

Analysis of Long-Term Performance of PV Systems

Different Data Resolution for Different Purposes



Front page picture courtesy of Amitec Ltd. from the SolAmitec Solar Monitoring System.

INTERNATIONAL ENERGY AGENCY
PHOTOVOLTAIC POWER SYSTEMS PROGRAMME

Analysis of Long-Term Performance of PV Systems

Different Data Resolution for Different Purposes

IEA PVPS Task 13, Subtask 1
Report IEA-PVPS T13-05:2014
November 2014

ISBN 978-3-906042-21-3

Authors:

Thomas Nordmann, nordmann@tnc.ch
Luzi Clavadetscher, clavadetscher@tnc.ch
TNC Consulting AG, Switzerland

Wilfried G.J.H.M. van Sark, w.g.j.h.m.vansark@uu.nl
Utrecht University, The Netherlands,

Mike Green, mike@lightning.co.il
M.G.Lightning Electrical Engineering, Israel,

Contributions and data:

Database and Analysis of PV Systems (Chapter 3)

Karl Berger, AIT Austrian Institute of Technology GmbH, Austria
Mauricio Richter, 3E, Belgium
Mike van Iseghem, EDF R&D, France
Lionel SICOT, Institut National de l'Energie Solaire (INES), France
Christian Reise, Fraunhofer-Institut für Solare Energiesysteme ISE, Germany
Mike Green, M.G.Lightning Electrical Engineering, Israel
Giorgio Belluardo, EURAC research, Institute for Renewable Energy, Italy
Dario Bertani, Ricerca sul Sistema Energetico – RSE S.p.A., Italy
Lorenzo Fanni, EURAC research, Institute for Renewable Energy, Italy
Giussani Mattia, Ricerca sul Sistema Energetico – RSE S.p.A., Italy
Salam Zainal, Universiti Teknologi Malaysia (UTM), Malaysia
Anne Gerd Imenes, University of Agder, Norway
Luis Casajus Medrano, Centro Nacional de Energías Renovables, Spain
Johan Ärlebäck, Paradisenergi AB, Sweden
Sarah Kurtz, National Renewable Energy Laboratory (NREL), USA
Ryan M Smith, National Renewable Energy Laboratory (NREL), USA

Contributions of Data for Statistics on the Operation of PV Systems (Chapter 4)

Lyndon Frearson, CAT projects, Australia
Paul Rodden, CAT projects, Australia
Nils Reich, Fraunhofer-Institut für Solare Energiesysteme ISE, Germany
Francesca Tilli, Gestore dei Servizi Energetici (GSE) S.p.A, Italy
Kendall Esmeijer, Utrecht University, The Netherlands
Panagiotis Moraitis, Utrecht University, The Netherlands
Dirk Jordan, National Renewable Energy Laboratory (NREL), USA

This report is supported by the following entities:

Members of the IEA PVPS Pool Switzerland:

Energy Consultancy, Canton Basel City
Municipal Utility of Zurich (EWZ)
ScanE, Canton Geneva
Mont Soleil Association
Swiss Federal Office of Energy (BFE)
SWISSOLAR

Netherlands Enterprise Agency (NL)

Israel Energy and Water Resources Ministry
M.G. Lightning.ltd (ISR)
Unirom ltd (ISR)
Arava Power Company (ISR)

Executive Summary

This report describes the activities, conclusions and continued efforts undertaken in Subtask 1 by the participating countries in IEA-PVPS Task 13. Subtask 1 examines the PV power plant as a system. It collects and studies the data supplied from installed operating PV plants from different countries in order to understand better the efficiency and reliability of the current state of the art.

Three Activities were defined for Subtask 1 as follows:

Activity 1.1: Database and Analysis of PV systems

Activity 1.2: Statistics on the operation of PV systems in operation for more than 5 years

Activity 1.3: Failure analysis of operational PV systems in an attempt to understand cause and effect in PV system failure

Database and Analysis of PV Systems

The purpose of Activity 1.1 is to enrich and maintain the existing online performance database and to add new operational data from existing and new grid-connected PV systems. The activity deals with quality data only, selected and analysed for usability by experts from each of the contributing countries.

Currently (May 2014), the PV online performance database contains operational data of 594 PV systems from 13 countries. Of these, data from 494 PV systems were collected during the former IEA PVPS Task 2. The spectrum ranges from small installations of less than 1 kW to power plants of more than 2 MW. The database includes datasets of PV systems with different cell technologies and type of mounting like flat roof, sloped roof, façade, ground mounted or PV sound barriers.

An important function is the possibility to filter the available data within the database. This allows a comparison of the different plant data within the sorted arguments. Pre-defined filter criteria are:

- Year of construction
- Type of plant (i.e. flat roof, sloped roof, facade, etc.)
- Installed nominal power
- Country
- Cell technology

Using the filter options it is not only possible to analyse single PV systems but to draw graphs for a whole group of plants.

Beside the pre-configured filter and display options, other variants of filters and graphs may be desired. So it is possible to export the data to a spreadsheet application like Microsoft Excel. In this way, it is possible to create own graphs and to analyse the data in more detail.

Statistics on the Operation of PV Systems

Activity 1.2 takes the opposite approach, by attempting to answer the question “*How well is PV serving the world*”. Therefore, only three parameters from as many PV systems as possible are analyzed:

- Annual yield (kWh per installed kWp)
- Performance Ratio PR
- Degradation rate

Participants in the Task 13 have attempted to collect appropriate data for a large amount of PV systems. Notably data from Italy, USA and Australia have been supplied for this. Limited data availability from other participating countries has been addressed by using so-called web scraping techniques that collect and organize performance data automatically in databases. In order to study correlation between performance and system size, data have been divided into system power classes ranging from < 1 kWp to > 10 MWp. In addition, performance data can be related to climate zones. Unfortunately, the amount of data collected did not allow for determination of degradation rates.

We can conclude from data analyses that today’s PV systems are in general “delivering what the salesman says”, with country differences in annual yield that can well be explained by irradiation differences or climate zone differences.

In order to follow the constantly growing PV market and the decentralized energy production we recommend to develop more sophisticated monitoring tools. The creation of large databases has the advantage of high-resolution information that could give a clear image of the overall performance and the weak points of each installation. Moreover, it is possible to further study the performance mechanisms and the dependence over various factors.

Failure Analysis of PV Systems

The previous activities dealt with analysis of the PV system efficiency. This activity 1.3 is aimed at finding the root cause of the faults that lead to system downtime or low efficiency, as expressed by a low Performance Ratio or efficiency.

A study has begun to find correlation between defined faults, either hardware failure or low efficiency, and the system parameters immediately before the fault as compared to long before the fault.

The systems under study were and will be monitored for efficiency. When the efficiency drops or a failure becomes apparent the system parameters will be examined and compared to periods of time past.

It is assumed that a correlation between monitored system parameters and specific failures can be found and catalogued. If a statistical correlation can be found between the changing characteristics of specific parameters and specific fault types, these correlations could be used as signs for impending failure. Such correlations could then be used to alert the owner on faults when no Performance Ratio monitoring exists.

Table of Contents

Executive Summary	1
1. Foreword	5
2. General introduction	7
3. Database and analysis of PV systems	9
3.1 Introduction.....	9
3.2 Concept / terms	10
3.3 Using the IEA PVPS Performance Database	11
3.3.1 Analysing single PV systems.....	13
3.3.2 Analysing groups of PV systems using filter criteria	14
3.4 Data input and quality assurance	21
3.4.1 Quality over quantity.....	21
3.5 Present state of the PV Performance Database	22
4. Statistics on the operation of PV systems	24
4.1 Introduction.....	24
4.2 Methodology.....	24
4.2.1 Data from participants	24
4.2.2 Data from the Internet.....	26
4.3 Results	26
4.3.1 Data from participants	26
4.3.2 Data from the Internet.....	31
4.4 Conclusion.....	35
5. Failure analysis of PV systems.....	37
5.1 Introduction.....	37
5.2 Background	37
5.3 Methodology.....	38
5.3.1 Temperature corrected Performance Ratio	39
5.3.2 Cataloging	40
5.3.3 The monitoring.....	40
5.3.4 Protocol	41
5.4 Results	42
5.5 Discussion / analysis	45
5.6 Conclusion / summary	45
References	47
Annex: Definitions	49

1. Foreword

The International Energy Agency (IEA), founded in November 1974, is an autonomous body within the framework of the Organization for Economic Co-operation and Development (OECD) which carries out a comprehensive programme of energy co-operation among its member countries. The European Union also participates in the work of the IEA. Collaboration in research, development and demonstration of new technologies has been an important part of the Agency's Programme.

The IEA Photovoltaic Power Systems Programme (PVPS) is one of the collaborative R&D Agreements established within the IEA. Since 1993, the PVPS participants have been conducting a variety of joint projects in the application of photovoltaic conversion of solar energy into electricity.

The mission of the IEA PVPS programme is: To enhance the international collaborative efforts which facilitate the role of photovoltaic solar energy as a cornerstone in the transition to sustainable energy systems.

The underlying assumption is that the market for PV systems is rapidly expanding to significant penetrations in grid-connected markets in an increasing number of countries, connected to both the distribution network and the central transmission network.

This strong market expansion requires the availability of and access to reliable information on the performance and sustainability of PV systems, technical and design guidelines, planning methods, financing, etc., to be shared with the various actors. In particular, the high penetration of PV into main grids requires the development of new grid and PV inverter management strategies, greater focus on solar forecasting and storage, as well as investigations of the economic and technological impact on the whole energy system. New PV business models need to be developed, as the decentralized character of photovoltaics shifts the responsibility for energy generation more into the hands of private owners, municipalities, cities and regions.

The overall programme is headed by an Executive Committee composed of representatives from each participating country and organization, while the management of individual research projects (Tasks) is the responsibility of Operating Agents. By late 2014, fifteen Tasks were established within the PVPS programme, of which seven are currently operational.

The overall objective of Task 13 is to improve the reliability of photovoltaic systems and subsystems by collecting, analysing and disseminating information on their technical performance and failures, providing a basis for their assessment, and developing practical recommendations for sizing purposes.

The current members of the IEA PVPS Task 13 include:

Australia, Austria, Belgium, China, EPIA, France, Germany, Israel, Italy, Japan, Malaysia, Netherlands, Norway, Spain, Sweden, Switzerland, Turkey and the United States of America.

This report focusses on the results of analytical photovoltaic (PV) monitoring,. Three research groups present their studies as developed under the Task 13 umbrella. Each group draws on the international experience and expertise of the Task 13 members in researching, analyzing and reporting their results. Each group uses monitoring data of different resolution and quality, depending on the purpose of the research; degradation trending, PR trending, and failure analysis each require progressively fewer sets of higher quality data.

The report expresses, as nearly as possible, the international consensus of opinion of the Task 13 experts on the subject dealt with. Further information on the activities and results of the Task can be found at: <http://www.iea-pvps.org>.

2. General introduction

Talking about efficiency in photovoltaics (PV) the focus often lies on efficiency of cells or modules. However, it is worthwhile to devote at least equal attention to the overall efficiency of the entire photovoltaic system in order to make this technology a competitive and reliable alternative to conventional energy sources. Losses in inverters and cables, losses due to reflection and temperature effects as well as losses due to system outages can greatly affect the overall energy yield and thus the economic efficiency of a photovoltaic installation.

In recent years, great progress in terms of the overall efficiency of PV systems has been made, which is reflected for instance in a clearly measurable increase of the performance Ratio. The Performance Ratio PR (see definition in section 2.2) as an important indicator of PV systems efficiency is explained in more detail further on. Typical ranges of the PR rose from 50% - 75% in the late 1980s via 70% - 80% in the 1990s to typically >80% nowadays, with some systems reaching 90% [1]. Nevertheless the PR bandwidth of newly installed PV still varying from 70% - 90% shows the necessity of evaluating the performance of entire PV systems.

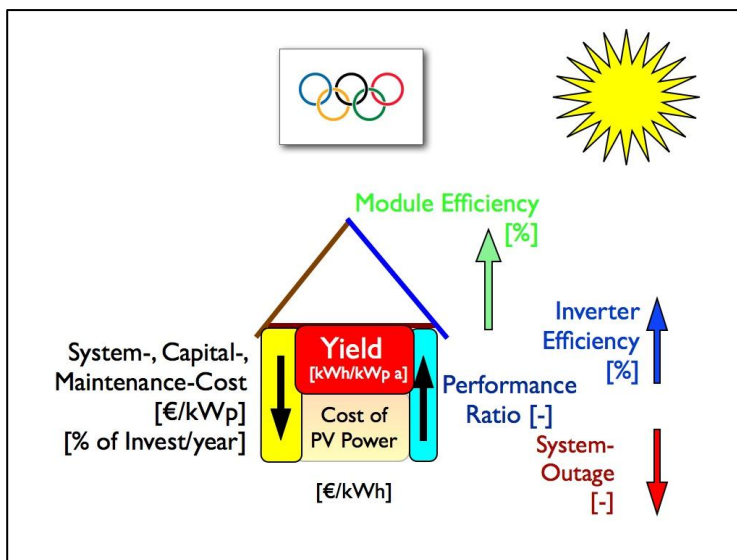

Figure 1: The Solar Olympics Pentathlon.

Considering financial aspects of PV power generation the main focus is often limited to specific costs of cells, modules or systems. The production costs per kWh however are influenced to a large extent by the cost of capital and the costs of operation and maintenance.

The latter are quite obviously affected by the reliability of the PV system. But the predictability and availability of PV power plants has also a considerable influence on the cost of capital, especially in the medium and long term. If it is possible to confirm the high reliability of this technology by independent and sound measurements over several years and for a large number of plants, the confidence of potential investors / creditors would increase continuously. In the end this would result in higher bankability, lower capital costs and hence lower production costs.

In an analogy to sports, aiming at an electricity supply based substantially on PV is more like competing in an Olympic multisport race than trying to win in one single discipline (Figure 1).

This report describes the activities, conclusions and continued efforts undertaken in Subtask 1 by the participating countries in IEA-PVPS Task 13. Subtask 1 examines the PV power plant as a system. It collects and studies the data supplied from installed operating PV plants from different countries in order to understand better the efficiency and reliability of the current state of the art.

Three Activities were defined for Subtask 1 as follows:

Activity 1.1: Database and Analysis of PV systems (chapter 3)

Activity 1.2: Statistics on the operation of PV systems in operation for more than 5 years (chapter 4)

Activity 1.3: Failure analysis of operational PV systems in an attempt to understand cause and effect in PV system failure (chapter 5)

3. Database and analysis of PV systems

3.1 Introduction

This activity redefines the existing PVPS online PV performance database in co-operation with all Task 13 members. An adapted reporting format is created taking into account the results of the updated monitoring guidelines [3] elaborated within the European Project PERFORMANCE (Subproject 3) [4]. The present structure of the database has been left as it is, but is fully integrated into the online version of the database. The off-line version of the database will be discontinued.

The target audience of the PV Performance database is:

- PV planners
- PV component manufacturers
- PV plant owners
- Vocational schools
- Research laboratories
- Utilities
- Government agencies
- NGOs

New performance data from existing systems in the database is collected from Task 13 members and other members of PVPS. New systems have been added. It is of importance that only consistent high quality data is added to the database. Each national member has to ensure the quality of the data supplied.

With high quality data it is possible to analyze the data in depth and create automatic online reports on a regular basis. This enhances the online database and attract a wider audience.

The emphasis on the reporting will be issues not fully covered in earlier Task 2 reports [5] [6] like module temperature, operational efficiencies, failure rate, and long-term system performance as well as system degradation.

Recorded values of in-plane irradiation are not available for all plants with a sufficient accuracy needed for the observation of possible system degradation. Therefore, an additional task of this activity is to validate the irradiation resource on a tilted (or tracked) plane for a duration of ten or more years in the past. For this purpose, site specific and quality controlled irradiation data may be provided through a co-operation with IEA SHCP Task 36 and other sources.

3.2 Concept / terms

In order to measure and compare the efficiency of entire PV systems it is necessary first to describe the whole energy conversion chain from solar irradiation input to electricity fed into the grid by suitable and normalized quantities. The normalized evaluation and presentation of the operational data in the IEA PVPS Performance Database is based on the Standard IEC 61724, "Photovoltaic System Performance Monitoring – Guidelines for Measurement, Data Exchange and Analysis". Because the database comprises grid-connected PV-systems only some adaptations were implemented [2], [3].

Figure 2 shows a schematic illustration of grid-connected PV-systems along with the most important parameters. H_i represents the incoming solar irradiation onto a PV-Array. E_A describes the DC-energy output of the array, for the purpose of simplicity, we assume this to be equal to energy E_{II} which is fed into the inverter. As the cell temperature has a significant influence to the efficiency of PV-modules ambient temperature T_{am} and module temperature T_m are important for the complete description of the PV system.

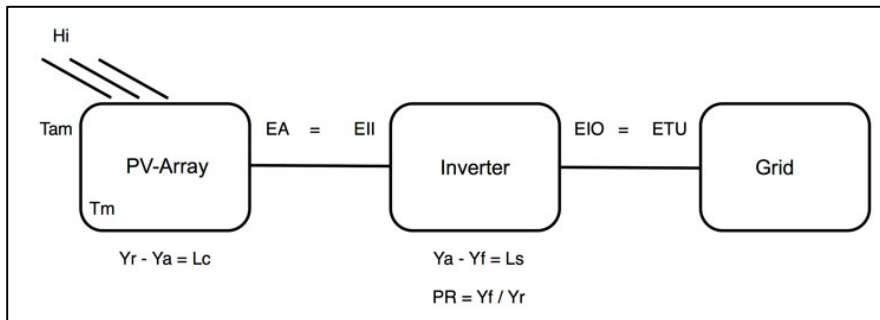

Figure 2: Normalized evaluation of a grid-connected PV-system.

Knowing reference yield Y_r and array yield Y_a , capture losses L_c can be calculated. Beside the mentioned temperature effects there are several more factors that can contribute to generator losses, such as partial shading, soiling, reflection, MPP-tracking-errors, conductor losses, and mismatch.

The inverter transforms DC energy E_{II} into AC energy E_{IO} , which is fed into the grid (E_{TU}). System losses of the inverter are calculated as the difference between Y_a and the normalised final yield Y_f .

The Performance Ratio PR calculated from Y_f (AC side) and Y_a (DC side) is the ratio between the energy actually generated to the energy an ideal lossless PV plant would have produced with the same amount of irradiation energy and at a module temperature of 25 °C. The PR is one of the most useful key figures to determine the efficiency of PV-systems regardless of module efficiency.

In the Annex further recorded and derived parameters used for the PV Performance Database are listed. This standardization of parameters is crucial to allow a profound analysis and comparison of PV systems.

3.3 Using the IEA PVPS Performance Database

The IEA PVPS Performance Database is basically open to everybody after registration. The database is available under the following address in the Internet:

<http://www.iew-pvps.org>

With a web browser the data of PV plants from different countries, sizes, and years of construction acquired and evaluated during the Task 2 (1993-2007) and Task 13 (after 2010) , can be accessed with an easy to use graphical interface.

A search function allows for access to the data of a specific plant. In the overview “Plant” the most important project specific data such as nominal power, number of modules or geographic location can be viewed. In further menus more detailed information such as type of the inverters and modules or the combination of the modules to strings can be accessed. The recorded data is evaluated and displayed in tables and graphs on a monthly base and in an annual overview, such as shown in Figure 3. The exemplary graph shows the monthly data from 2012 of a PV plant at Bolzano airport in Italy.

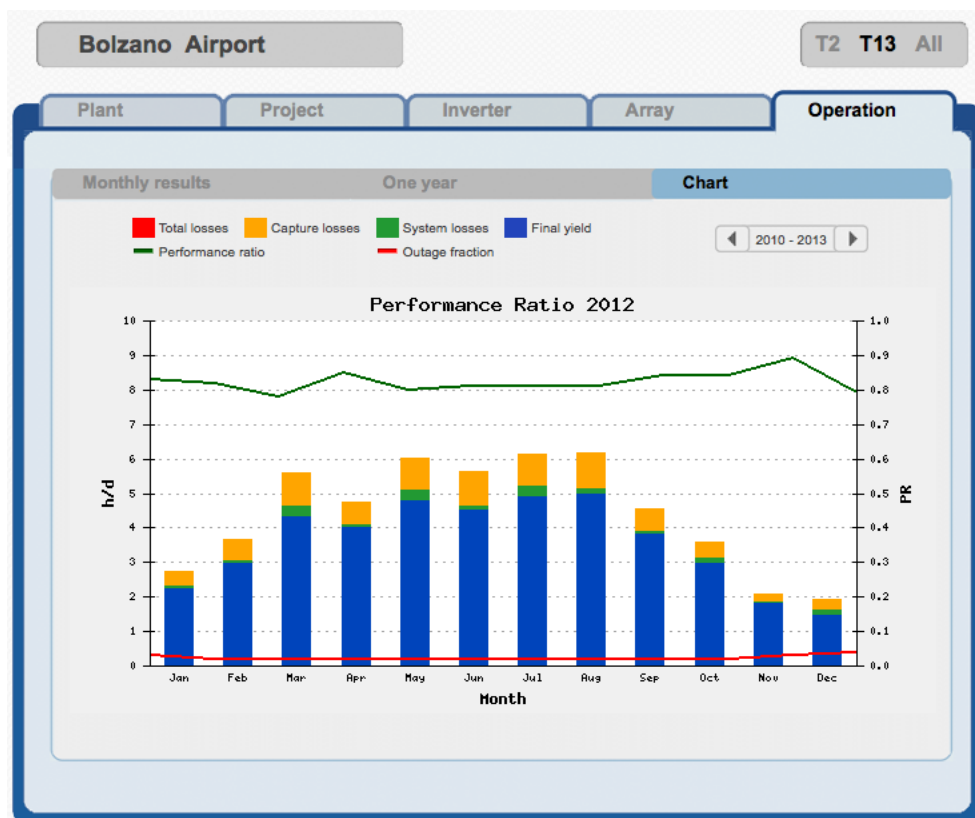

Figure 3: Screenshot of the online database: Yield of a PV plant at Bolzano airport (Italy).

The 12 bars in the Figure 3 show the monthly average of the normalized yield per day. The normalization shows the average full operational hours per day. The overall height of the bar represents the Reference Yield Yr. The yellow part represents the array capture losses L_c , while the green part stands for the system losses L_s . If the part for capture losses and system losses is not available the total losses is shown in red. The blue part represents the final yield of the plant. The green line symbolises the (AC) Performance Ratio PR. It is not a straight line, due to different influences such as temperature effects or snow coverage of the modules. Additional information such as the outage fraction is shown with a red line. Outage can be caused by an outage of the inverters or of the overall system. Another important function is the possibility to filter the available data within in database. This allows a comparison of the different plant data within the sorted arguments. Pre-defined filter criteria are shown in Figure 4:

- Year of construction
- Type of plant (i.e. flat roof, sloped roof, facade, etc.)
- Installed nominal power
- Country
- Cell technology

Figure 4: Filter criteria with the online database.

Within the filtered data, there is still the possibility to display the data on a monthly or annual base in form of tables. Additionally, there are five normalized and pre-defined graphical displays of the data available which can be applied to the filtered data.

3.3.1 Analysing single PV systems

Figure 5 shows the monitored annual Performance Ratio of a single PV system at Jungfrauoch in the Swiss Alps (3'471 meters above sea level) for 16 years of operation. It can be seen that the PR of this system stays almost constant at about 0.8 over this time period.

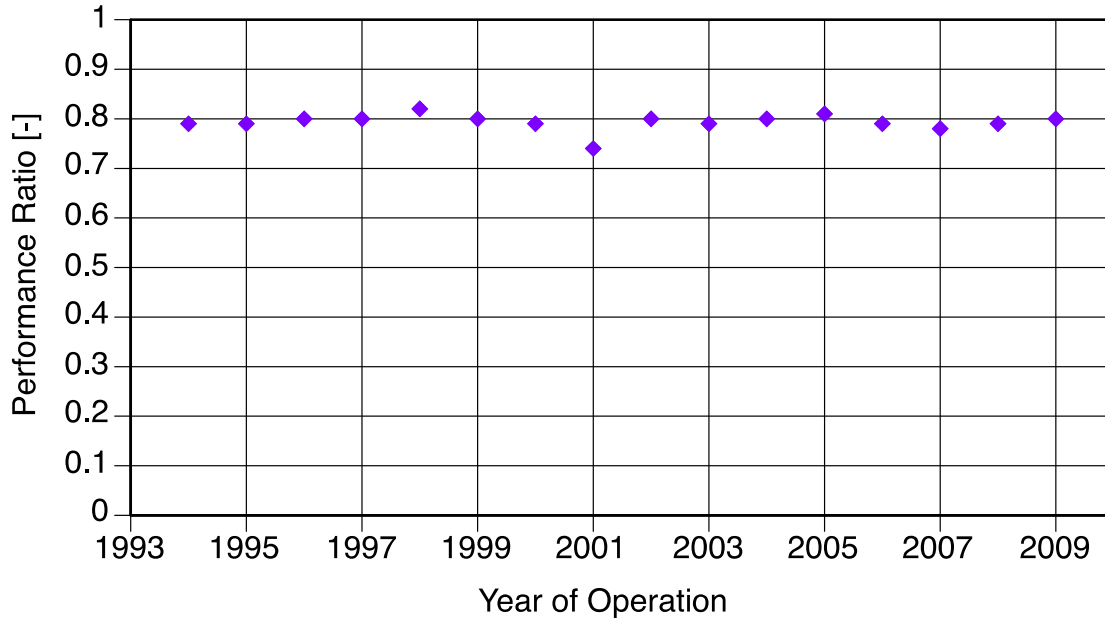

Figure 5: Annual Performance Ratio of a PV system in Switzerland.

In comparison Figure 6 shows the same type of chart for a selected PV system in Germany. The annual PR decreases significantly over the monitored time of 9 years. Possible reasons for this decrease are degradation effects of the PV cells.

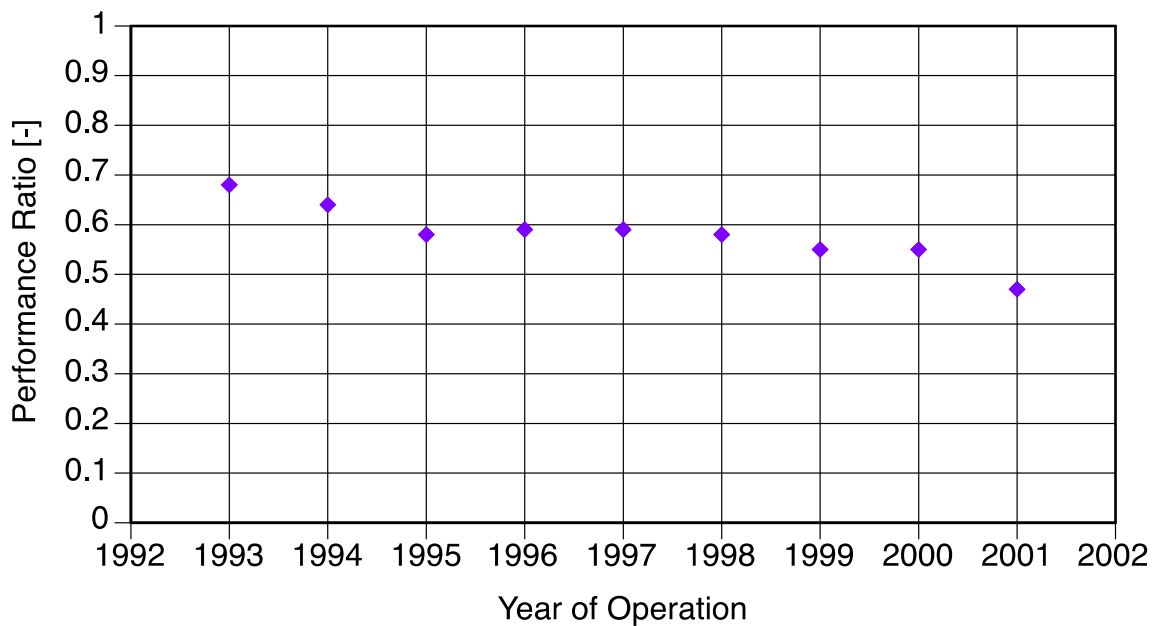

Figure 6: Annual Performance Ratio of a PV system in Germany.

The annual PR of a third PV system located in Italy is shown in Figure 7. The PR of this system is varying noticeably over the monitoring period of 13 years. This indicates that the system experienced several outages since being installed.

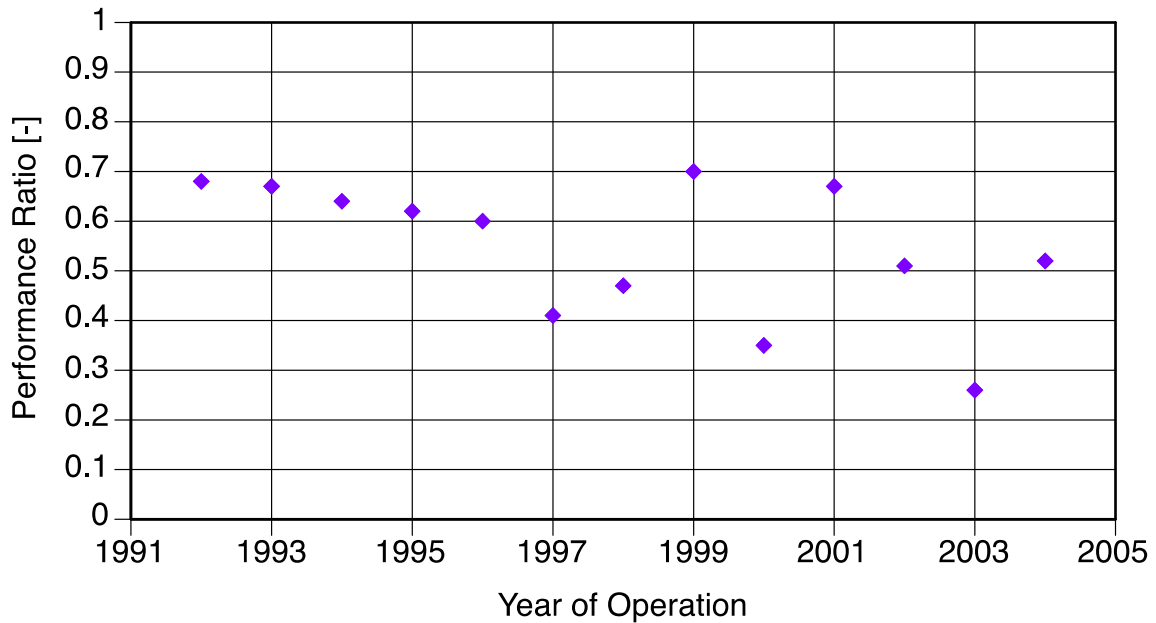

Figure 7: Annual Performance Ratio of a PV system in Italy.

3.3.2 Analysing groups of PV systems using filter criteria

Using the filter options it is not only possible to analyse single PV systems but to draw graphs for a whole group of plants.

Figure 8 and Figure 9 show two charts of operational data from PV systems filtered by year of installation. Figure 8 shows the annual PR for PV systems installed between 1983 and 1990. Figure 9 shows the annual PR for PV systems installed between 2005 and 2012. Comparing the two graphs it is visible that more operational data is available for the more recent years. Furthermore it can be seen that the PR of the PV systems installed in the 80s vary around a value of 0.7 whereas the PR of the newer plants show typical values of 0.8.

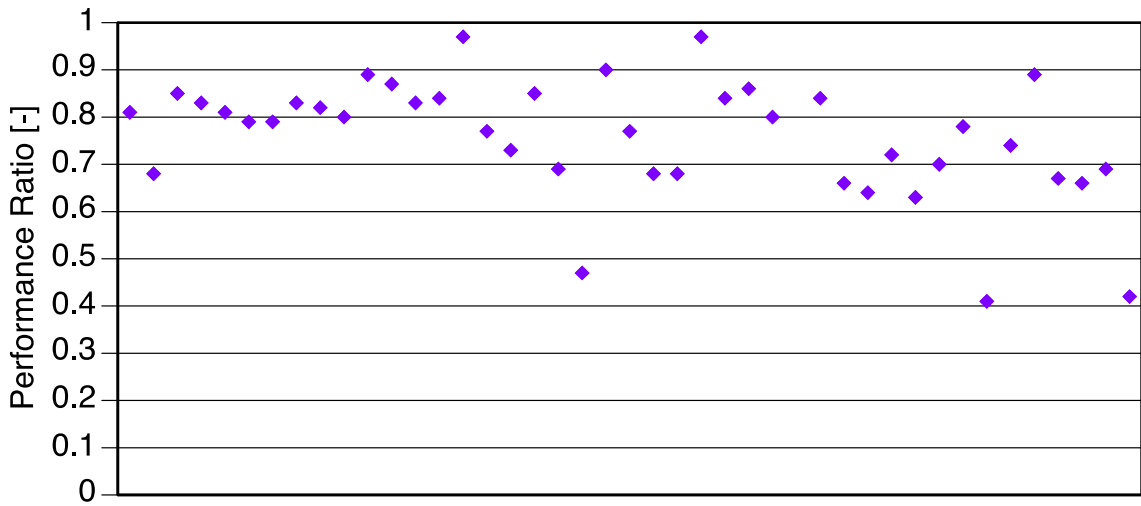

Figure 8: Performance Ratio of PV systems installed between 1983 and 1990 Plotted in the order of each plant-name and year of operation in the x-axis.

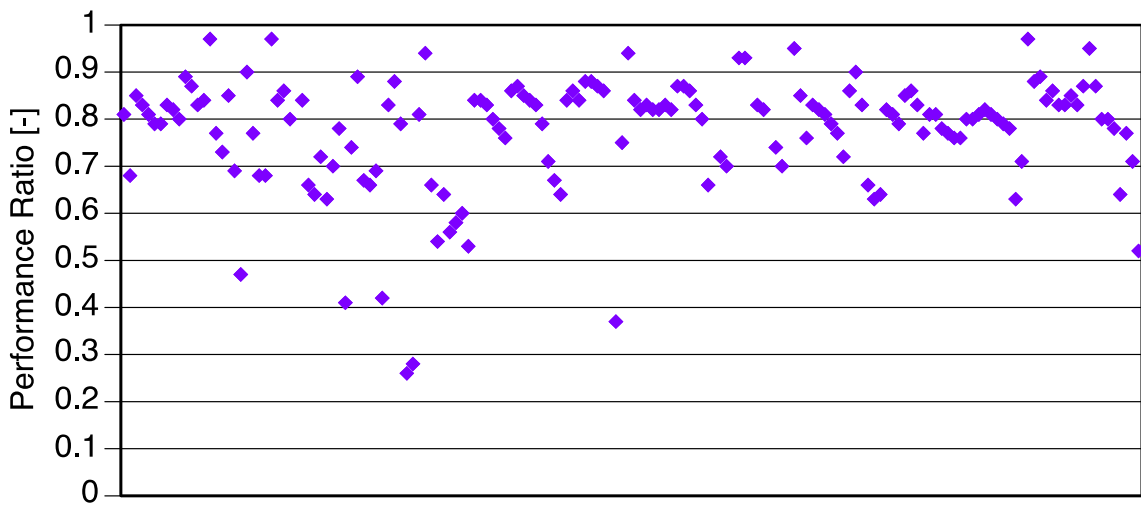

Figure 9: Performance Ratio of PV systems installed between 2005 and 2012 Plotted in the order of each plant-name and year of operation in the x-axis.

Figure 10 and Figure 11 show two more graphs of the same PV systems discussed above. Here the final yield is plotted versus the reference yield. Figure 10 shows data for systems installed from 1983 – 1990, Figure 11 shows data for systems installed between 2005 and 2012. The blue line represents a PR of 1, i.e. an ideal PV system without losses under standard test conditions. A constant PR <1 would be represented by a line starting at 0 with slope corresponding to the PR. The further a data point, i.e. the annual final yield is away from the blue PR=1 line the lower the PR of the PV system for the respective year of operation. Comparing the cloud diagrams the data points in Figure 11 are closer to the blue line indicating a higher PR for the more recent PV Installations.

This way of illustrating system performance is useful to compare a great amount of datasets graphically in order to analyse the influence of different factors such as cell technology, mounting type or others.

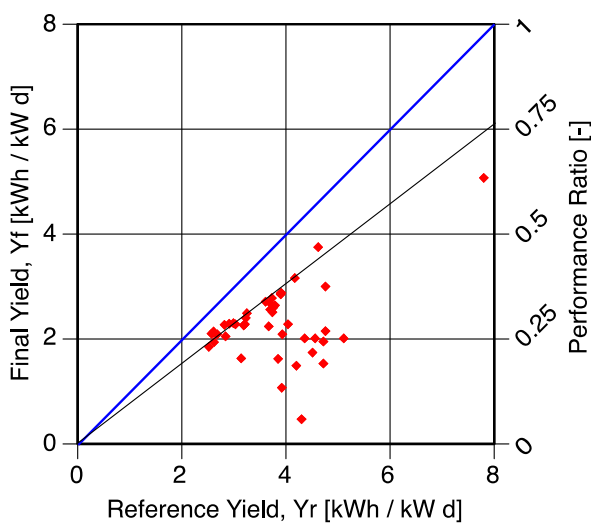

Figure 10: Final yield vs. reference yield for PV systems installed between 1983 and 1990 (Task 2).

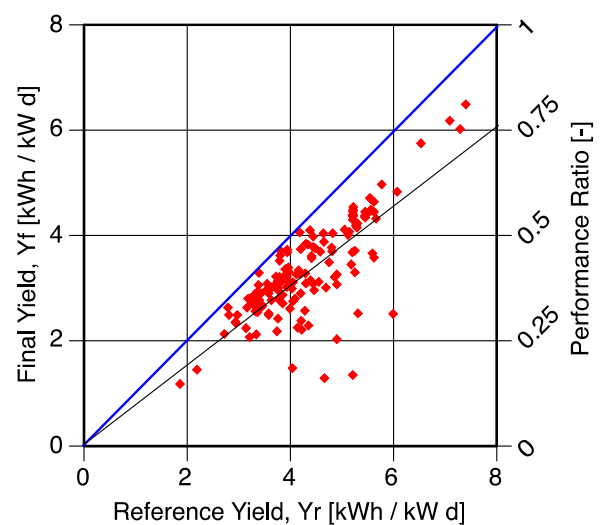

Figure 11: Final yield vs. reference yield for PV systems installed between 2005 and 2012 (Task 2 & 13).

A third predefined chart type is shown in Figure 12. For the example of Great Britain, the annual final yield in kWh/kW_p is plotted. The values are not only influenced by the PR of the system but by the irradiation available at the location. Most values vary between 300 and 650 kWh/kW_p.

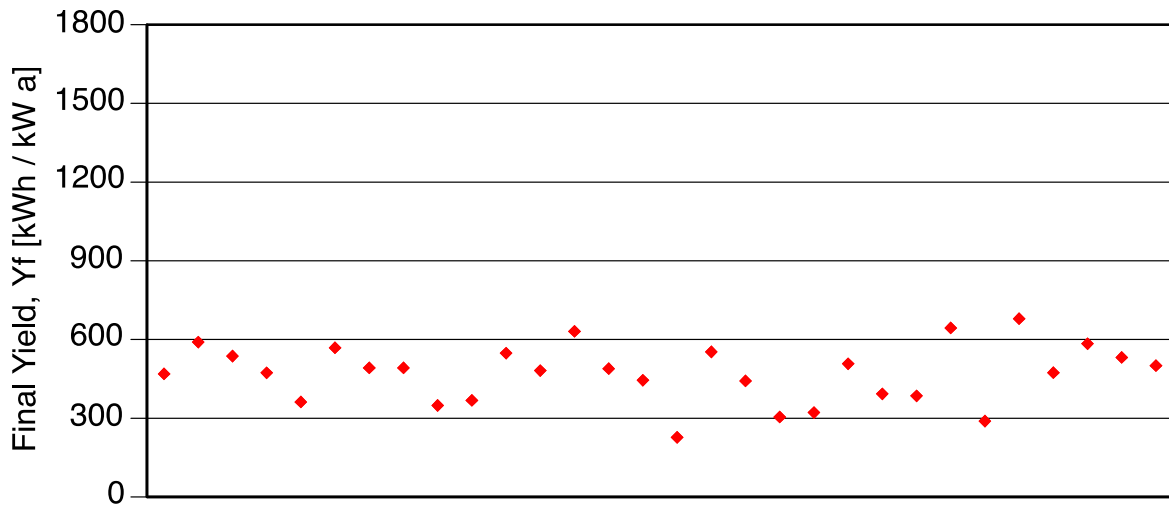

Figure 12: Annual final yield for PV systems in Great Britain. Plotted in the order of plant-name and year of operation.

In Figure 13 the same type of chart is plotted for PV systems in Italy. As expected the values are higher than for Great Britain ranging from 600 to values of almost 1800 kWh/kW_p.

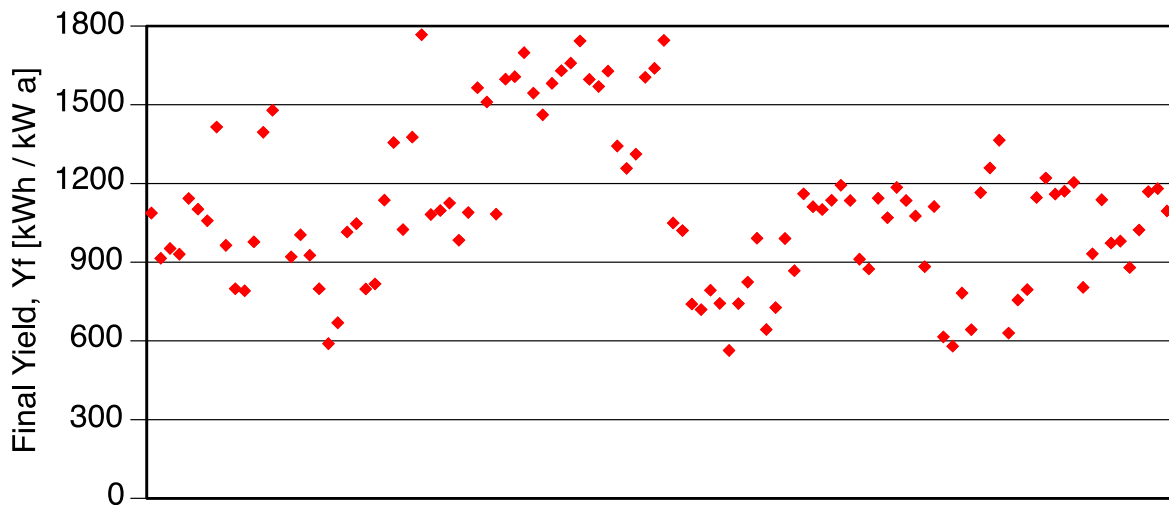

Figure 13: Annual final yield for PV systems in Italy. Plotted in the order of plant-name and year of operation.

Figure 14 shows the fourth predefined type of graph of the database web application for PV systems in Switzerland (left) and Italy (right). In this graphs the operational array efficiency η_A is plotted vs. the nominal (theoretical) array efficiency $\eta_{A,STC}$ at standard test conditions. Standard test conditions (STC) are defined by a irradiation of 1000 W/m^2 in the module plane, a module temperature of 25°C and a light spectrum at air mass (AM) of 1.5. As the charts are based on monthly data it is possible to illustrate and compare the range of the array efficiencies within the monitored years for selected PV systems. A major influence to the array efficiency is the seasonal change of the ambient temperature, which affects directly the temperature of the cells and therefore the cell efficiency. The red line in the diagrams represent an $\eta_A / \eta_{A,STC}$ ratio of 1. Although data values above this line are possible for some sites (e.g. a cold and sunny alpine location), the datasets need to be verified carefully to avoid having datasets based on measurement or calculation errors in the database.

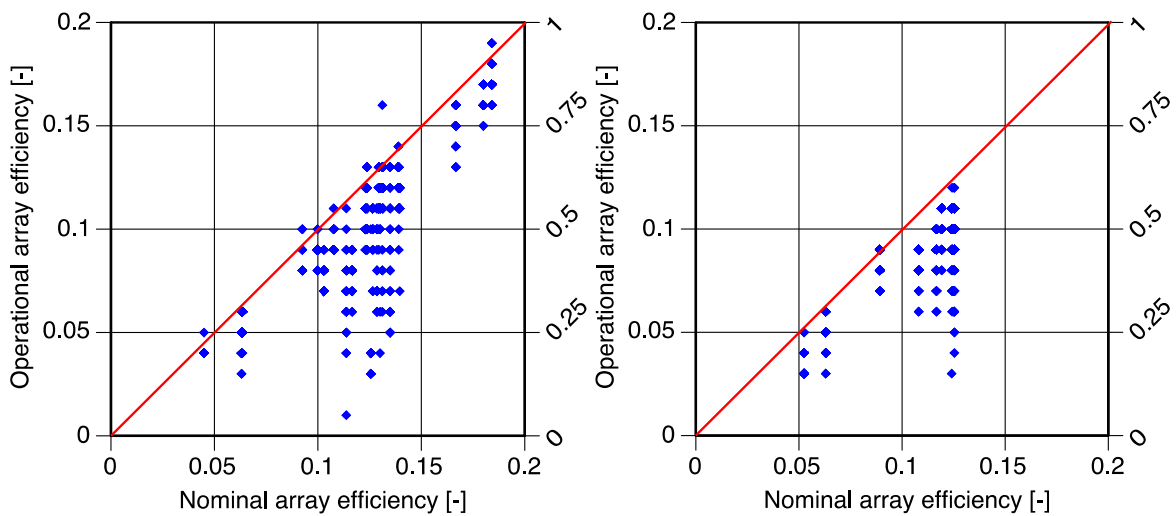

Figure 14: Monitored array efficiency vs. nominal array efficiency at standard test conditions STC; left: selected PV systems in Switzerland, right: PV systems in Italy.

Figure 15 shows an example of the 5th predefined chart type. Annual irradiation in the module plane is plotted versus the latitude of the respective PV system. Operational data of all participating PV plants of Task 13 are included in this chart. This illustrates the bandwidth of irradiation that is available for the different sites and gives an impression of the geographical distribution of the PV systems included in the database.

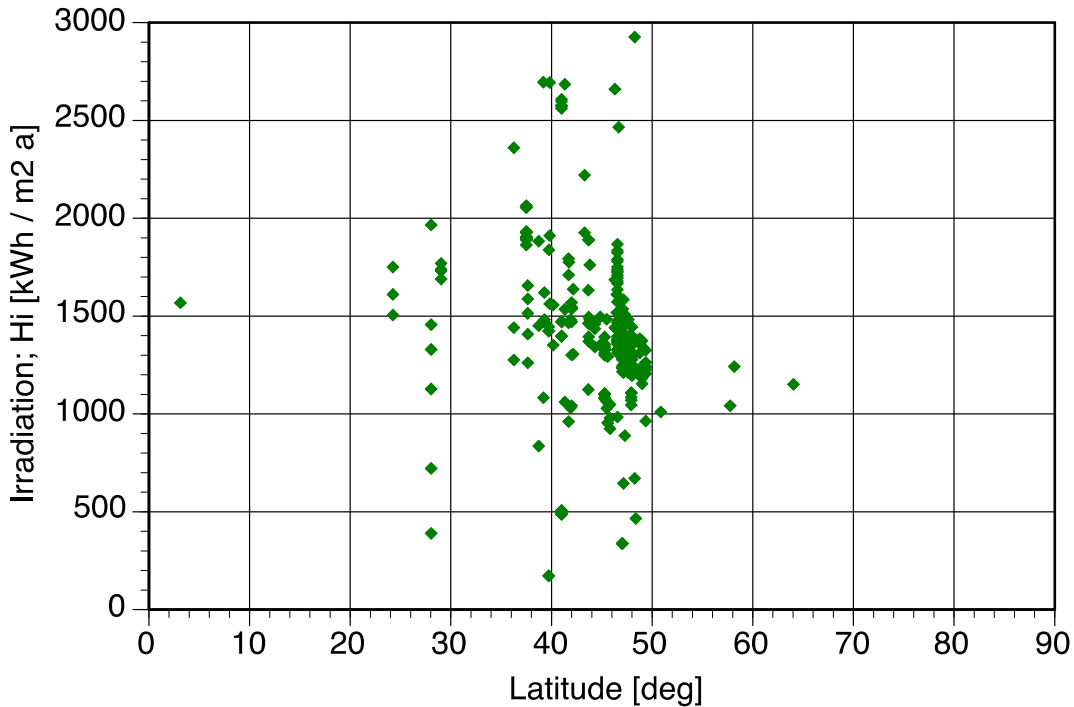

Figure 15: Annual irradiation in module plane vs. latitude of PV system location.

Beside these pre-configured filter and display options, other variant of filters and graphs may be desired. For that purpose, an export filter has been implemented. A simple and effective way of using the database individually is to list annual or monthly operational data in a table and subsequently export it to a spreadsheet application like Microsoft Excel. In this way, it is possible to create own graphs and to analyse the data in more detail.

3.4 Data input and quality assurance

3.4.1 Quality over quantity

For operational data of PV plants to be accepted in the PV Performance Database, pre-defined quality standards have to be fulfilled (see Figure 18). Several precautions have been taken to ensure the requirements of these standards are fully met. For every country there is one (or more) national expert who is responsible for quality assurance of the data provided from their respective country.

Quality of the recorded data is ensured with the definition of minimal requirements for the data measurements carried out. Calibrated solar irradiation measurements, a correct measurement of the module temperature as well as the measurement of the energy flows on DC and AC side of the PV system are part of these requirements. The data has to be measured with a high time resolution and derived values have to be calculated by using standardized and defined methods of calculation.

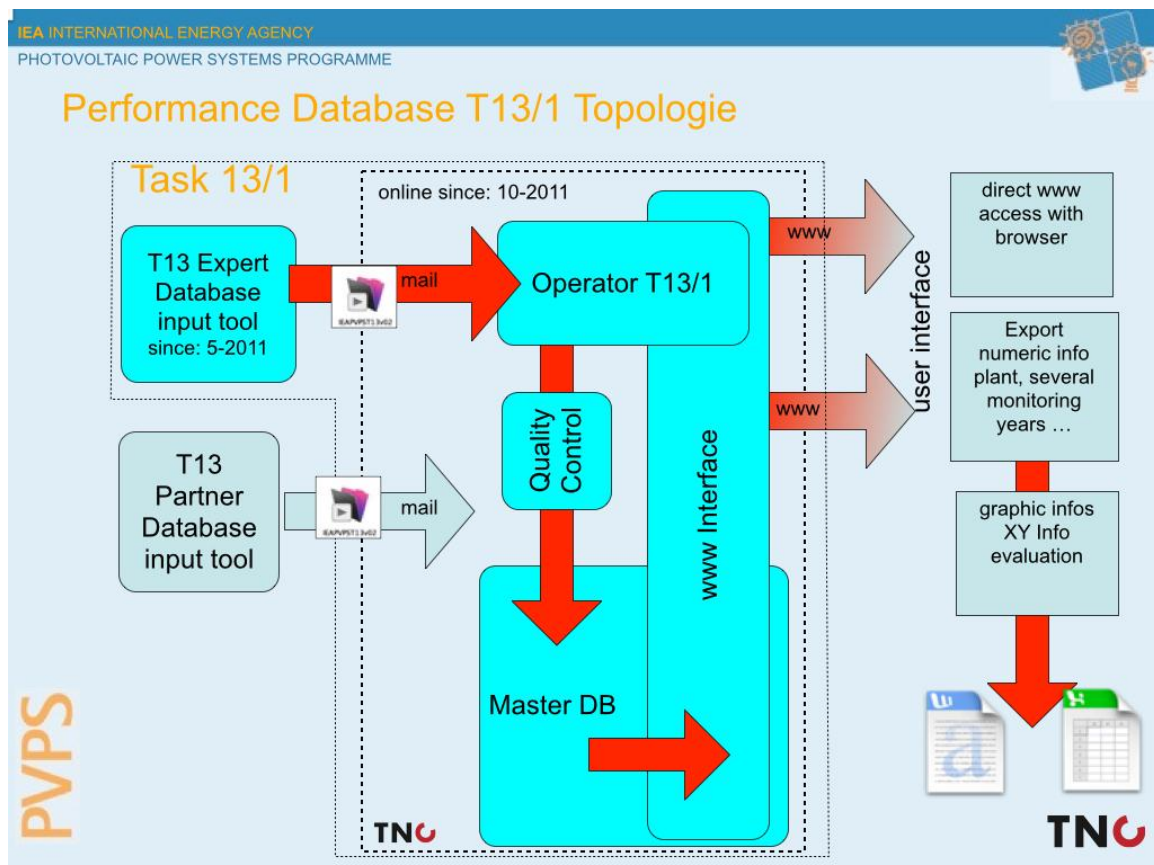

Figure 18: Topology of the PV Performance Database.

The national experts provide the measured and verified data to the database operator (TNC). For the process of entering data, a Filemaker runtime database is used (Figure 19). This Filemaker runtime database can be obtained for free from the database operator TNC. The user is provided with a standardized Excel Worksheet for entering the operational data into the import tool of the database. The import tool performs a check of the provided data. Incorrect inputs, such as logical contradictions, are detected and the user is prompted to correct the input. If the data sets fulfil the requirements, an export file is generated which then can be sent by email to the database operator. With this multi-level procedure it is assured that the minimal requirements for the quality of the data are fulfilled and the form of the data file is compatible with the database when it is provided to the database operator. The database operator conducts a last check of the data before importing the data sets into the main database.

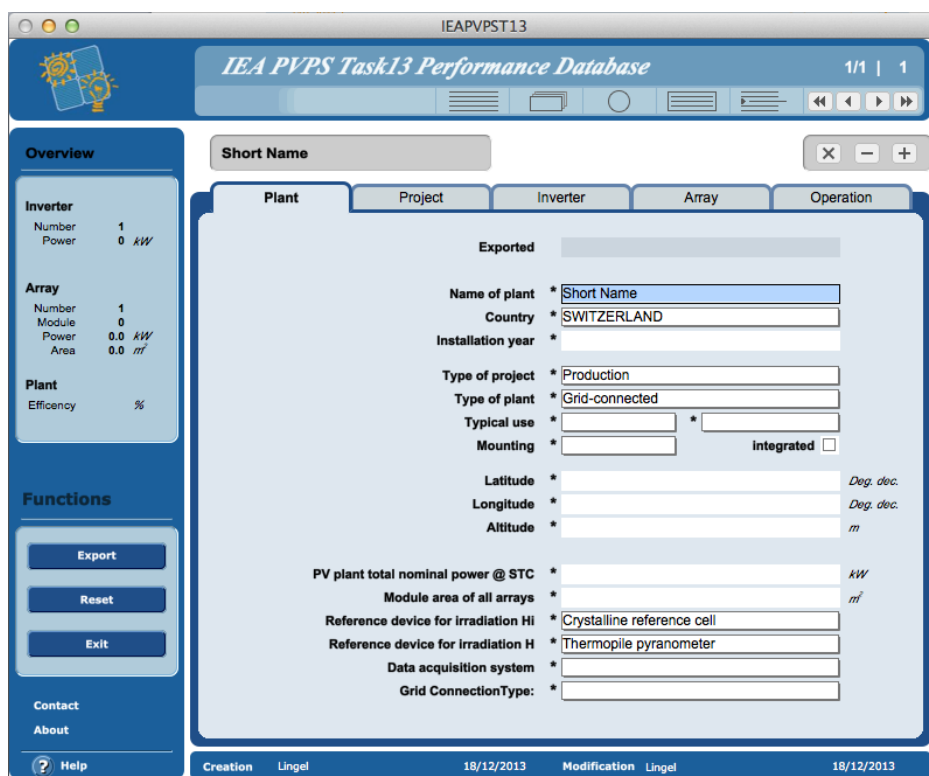

Figure 19: Screenshot of Filemaker runtime database.

3.5 Present state of the PV Performance Database

Currently the PV performance database contains operational data of 594 PV systems from 13 countries. Of these, data from 494 PV systems were collected during Task 2. The spectrum ranges from small installations of less than 1 kW to power plants of more than 2 MW. The database includes datasets of PV systems with different cell technologies and type of mounting like flat roof, sloped roof, façade, free standing or PV sound barriers.

Country	PV Systems	P0 (kW)	Systems with Data	Months of Data
AUSTRIA	4	201		
BELGIUM	1	3	1	10
FRANCE	7	21	7	91
GERMANY	7	2,914	7	516
ISRAEL	1	51		
ITALY	31	943	31	1,078
MALAYSIA	1	45	1	12
NORWAY	1	45	1	29
SPAIN	1	14	1	72
SWEDEN	10	322	5	52
SWITZERLAND	11	1,464	10	1,434
UNITED STATES	25	2,464	21	1,349

Figure 20a: The amount of datasets collected by March 2014 within Task 13.

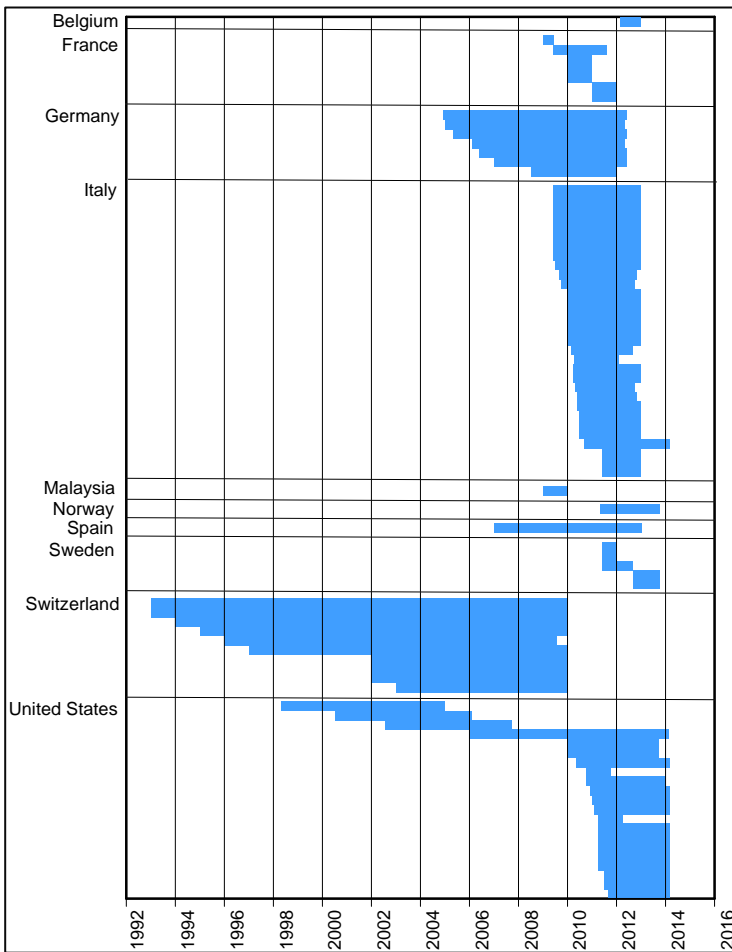

Figure 20b: Time and country of data collection by March 2014 within Task 13.

4. Statistics on the operation of PV systems

4.1 Introduction

Over the past years the development of solar PV technology in combination with low installation and maintenance costs made PV systems a popular form of renewable electricity production. Especially, small and medium size domestic users have started to embrace solar technology in order to reduce their utility bills. The majority of domestic production is coming from a large amount of scattered systems that are less than 5 kW_p and operate under various conditions with insufficient monitoring equipment. Consequently, failures and energy losses remain undetected for a long time and due to limited data availability many performance validation studies were mainly focusing on a specific geographical area with a limited amount of systems. As larger systems usually are fitted with extensive monitoring equipment, better control of performance is possible.

The purpose of this study is to answer the question “*How well is PV serving the world?*”. In answering this, the focus is on annual data in order to focus on what a customer/PV owner wants to know. Only three numbers will be reported:

- Annual yield (kWh per installed kW_p)
- Performance Ratio PR
- Degradation rate

The simplicity of reporting only three numbers (but for a large number of systems) allows easy communication of the results to the PV customers/owners who wish to know “*Will this PV system REALLY deliver what the salesman says?*”

Participants in the Task 13 have attempted to collect appropriate data for a large amount of PV systems. Notably data from Italy, USA and Australia have been supplied for this. Limited data availability from other participating countries has been addressed by using so-called web scraping techniques that collect and organize performance data automatically in databases.

4.2 Methodology

4.2.1 Data from participants

A data sheet template was developed to collect aggregated performance data, see Figure 21. Data is sorted per year of installation and system size, the latter in bins of one order of magnitude difference, viz. < 1 kW_p, 1...10 kW_p, 10...100 kW_p, 0.1...1 MW_p, 1...10 MW_p, and > 10 MW_p. Participants of the Task 13 were asked to collect data for different climate zones in their country, for instance Italy collected data for the North, Middle and the South. All data averaging was performed by the participants themselves to circumvent possible data confidentiality issues.

In the data sheet participants are requested to input:

- Number of systems
- Mean annual AC yield (kWh/kWp)
- Mean annual Performance Ratio
- Mean annual irradiation (kWh/m²)

For all data also standard error in the mean is requested. Also, participants are required to specify the way in which Performance Ratio was calculated (averaged daily, or monthly), and how irradiance was measured (local sensor or satellite).

Data provided by: (name/organisation)
 Date: 13/4/2013 (dd/mm/yy)
 Installation year: 2008 (year)
 Location (country, region, province, zip/postal code area)
 any remarks:

number of systems

year	systemsize					
	<1 kWp	1-10 kWp	10-100 kWp	0.1-1 MWp	1-10 MWp	>10 MWp
2008						
2009						
2010						
2011						
2012						

mean annual AC yield (kWh/kWp)

year	systemsize					
	<1 kWp	1-10 kWp	10-100 kWp	0.1-1 MWp	1-10 MWp	>10 MWp
2008						
2009						
2010						
2011						
2012						

mean annual Performance Ratio

year	systemsize					
	<1 kWp	1-10 kWp	10-100 kWp	0.1-1 MWp	1-10 MWp	>10 MWp
2008						
2009						
2010						
2011						
2012						

how was PR determined: (averaged daily or monthly PR)
 how was irradiation determined: (irradiance sensor/satellite)

mean annual irradiation (kWh/m²)

year	systemsize					
	<1 kWp	1-10 kWp	10-100 kWp	0.1-1 MWp	1-10 MWp	>10 MWp
2008						
2009						
2010						
2011						
2012						

(Note: irradiation for the specific set of systems may differ, therefore also here a distinction is made for size)

Figure 21: Data sheet template for data collection.

4.2.2 Data from the Internet

Limited data availability from other participating countries has been addressed by using so-called web scraping techniques that collect and organize performance data automatically in databases.

Monitoring applications that are available on the market today include a number of web tools that allow PV system owners to monitor system performance and the production of their system at any point of the day. The main monitoring market players are inverter manufacturers, project developers and independent monitoring vendors that integrate software and hardware in order to provide better customer service. In that way a large amount of high-resolution data is uploaded daily on web platforms and is available to the public.

The online service of Solar-Log was used, as it is one of the key players in monitoring with more than 80,000 system owners using the service. Also, it is one of the very few companies that offer free access to the users' web platform. The web-scraping software that was developed in this task in order to extract online data was able to simulate human navigation through web sources, to locate and save scattered information that was available to the user, and finally to organize that information in datasheets. In this way, daily yields (AC and DC) and all the operational details from 2914 systems in the Netherlands, Germany, Belgium, France and Italy were collected.

For the calculation of Performance Ratio in the Netherlands 31 stations of the Royal Netherlands Meteorological Institute (KNMI) provided hourly global horizontal irradiation data. Every PV installation was linked to the closest station according to geographical coordinates. The total plane of array irradiation was calculated on a daily basis using the Olmo model [7] for every system independently in accordance with the orientation and the tilt of each panel. High-resolution irradiation data was not available for the rest of the countries and therefore only the annual yield was calculated.

4.3 Results

4.3.1 Data from participants

Performance data was received and analyzed from the following countries:

- Australia, Northern Territory
- Germany
- Italy, regions North, Central, and South
- USA

An overview of the data is given in Figure 22. It is clear that statistical analysis can truly only be performed for data from USA. Nevertheless conclusions can be drawn for other countries as well. For example, in many countries larger systems show higher average annual yields compared to smaller systems, which is also clear from comparing Performance Ratio values, see Figure 23 for systems in Italy and Australia.

country/region	total number of systems (2008-2012)					
	<1 kWp	1-10 kWp	10-100 kWp	0.1-1 MWp	1-10 MWp	>10 MWp
Australia/NT	-	25	3	1	1	-
Germany	-	220	400	-	-	-
Italy/North	-	17	4	17	18	2
Italy/Central	-	15	4	15	13	1
Italy/South	-	17	5	15	8	3
USA	19	50903	10622	2915	300	-

country/region	yield (kWh/kWp)					
	<1 kWp	1-10 kWp	10-100 kWp	0.1-1 MWp	1-10 MWp	>10 MWp
Australia/NT	-	1680±222	1908±162	2013	1438	-
Germany	-	944±97	926±88	-	-	-
Italy/North	-	1133±44	1143±52	1056±23	1177±49	1330±50
Italy/Central	-	1289±54	1386±49	1235±56	1358±101	1584±10
Italy/South	-	1230±41	1382±64	1323±51	1367±41	1515±14
USA	1450±37	1424±48	1352±9	1338±8	1504±87	-

country/region	performance ratio					
	<1 kWp	1-10 kWp	10-100 kWp	0.1-1 MWp	1-10 MWp	>10 MWp
Australia/NT	-	0.79±0.10	0.94±0.12	0.921	0.69±0.04	-
Germany	-	-	-	-	-	-
Italy/North	-	0.741±0.013	0.721±0.014	0.723±0.014	0.768±0.002	0.820±0.015
Italy/Central	-	0.75±0.02	0.819±0.011	0.78±0.04	0.79±0.03	0.867±0.008
Italy/South	-	0.70±0.03	0.77±0.03	0.80±0.03	0.80±0.03	0.811±0.010
USA	-	-	-	-	-	-

country/region	irradiation (kWh/m2)					
	<1 kWp	1-10 kWp	10-100 kWp	0.1-1 MWp	1-10 MWp	>10 MWp
Australia/NT	-	2157±56	2165±64	2243	2172±100	-
Germany	-	-	-	-	-	-
Italy/North	-	1499±52	1583±51	1514±57	1533±68	1622±31
Italy/Central	-	1717±61	1744±64	1622±64	1699±74	1827±28
Italy/South	-	1730±43	1806±61	1672±63	1698±56	1868±41
USA	-	-	-	-	-	-

Figure 22: Summary of results: number of systems, yield, Performance Ratio, and irradiation, all averaged for period 2008-2012.

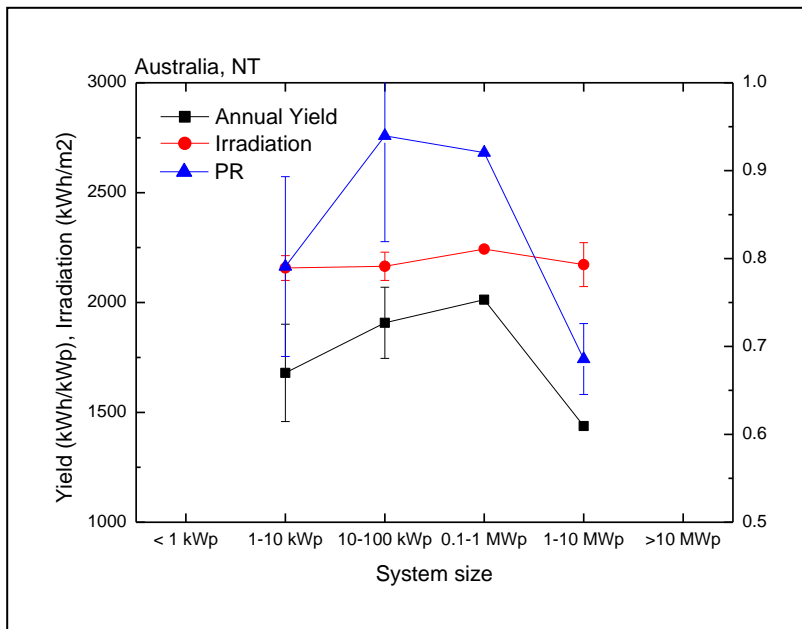
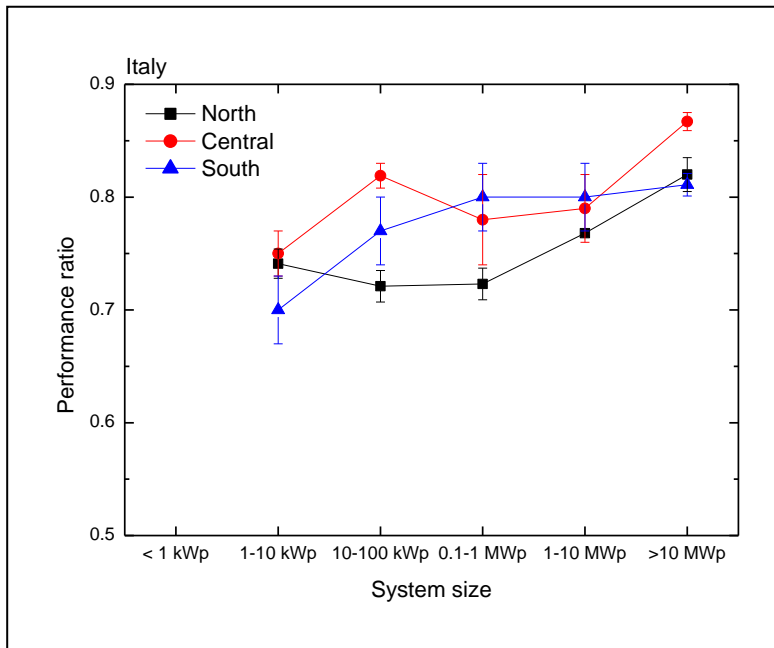

Figure 23: (top) Performance Ratio for all system sizes in Italy; (bottom) annual yield irradiation and PR in Australia.

With the limited amount of data it is not possible to determine degradation rates. Also, linking climatic zones to annual yields is difficult. However, as an example, the annual yield for 5 years for North, Central and South Italy is compared in Figure 24 (top). The annual yield for the North is clearly lower than the annual yield for Central and South Italy, which is due to the difference in irradiation, see Figure 24 (center). However, the Performance Ratio in Figure 24 (bottom) shows that systems in Central Italy perform best. Systems in the South clearly suffer from higher ambient temperatures. Interestingly, Performance Ratio values for systems in Australia, NT, are larger than Performance Ratio values in Italy, while ambient temperatures are higher.

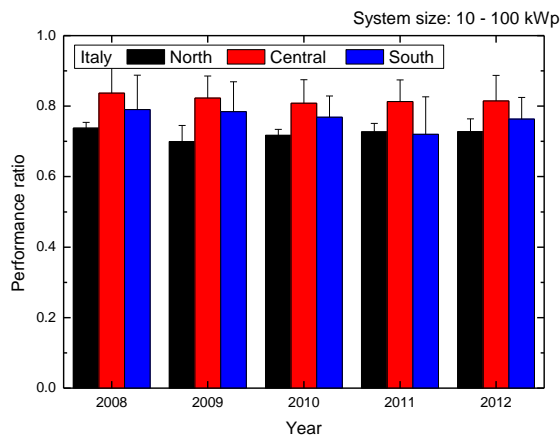
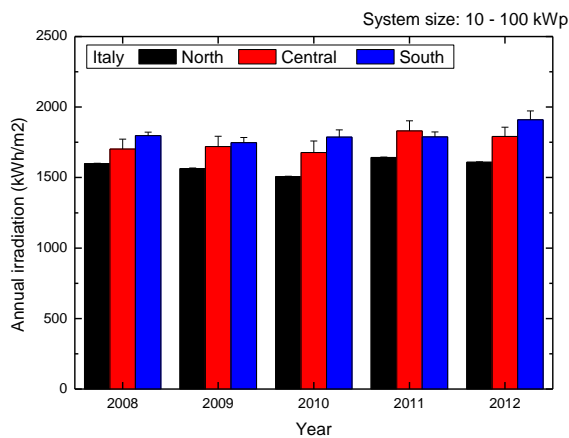
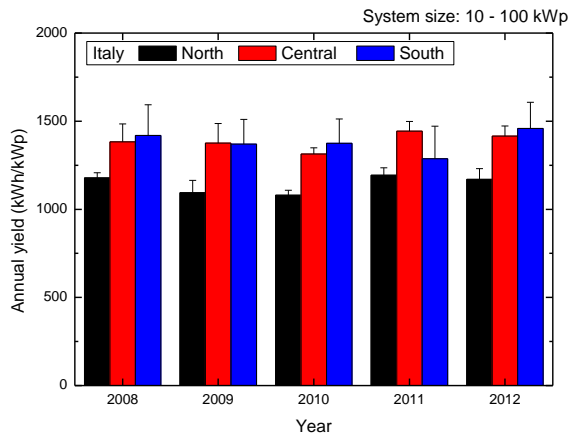

Figure 24: Annual yield, irradiation and Performance Ratio for systems of size 10-100 kWp for North, Central, and South Italy for systems installed in 2008-2012.

Analysis of USA data as shown in Figure 25 shows a clear relation with climatic differences in the USA: high yield values >2000 kWh/kWp are seen for systems in the South West and South East, while lower yield values <1300 kWh/kWp are observed in the North West and North East.

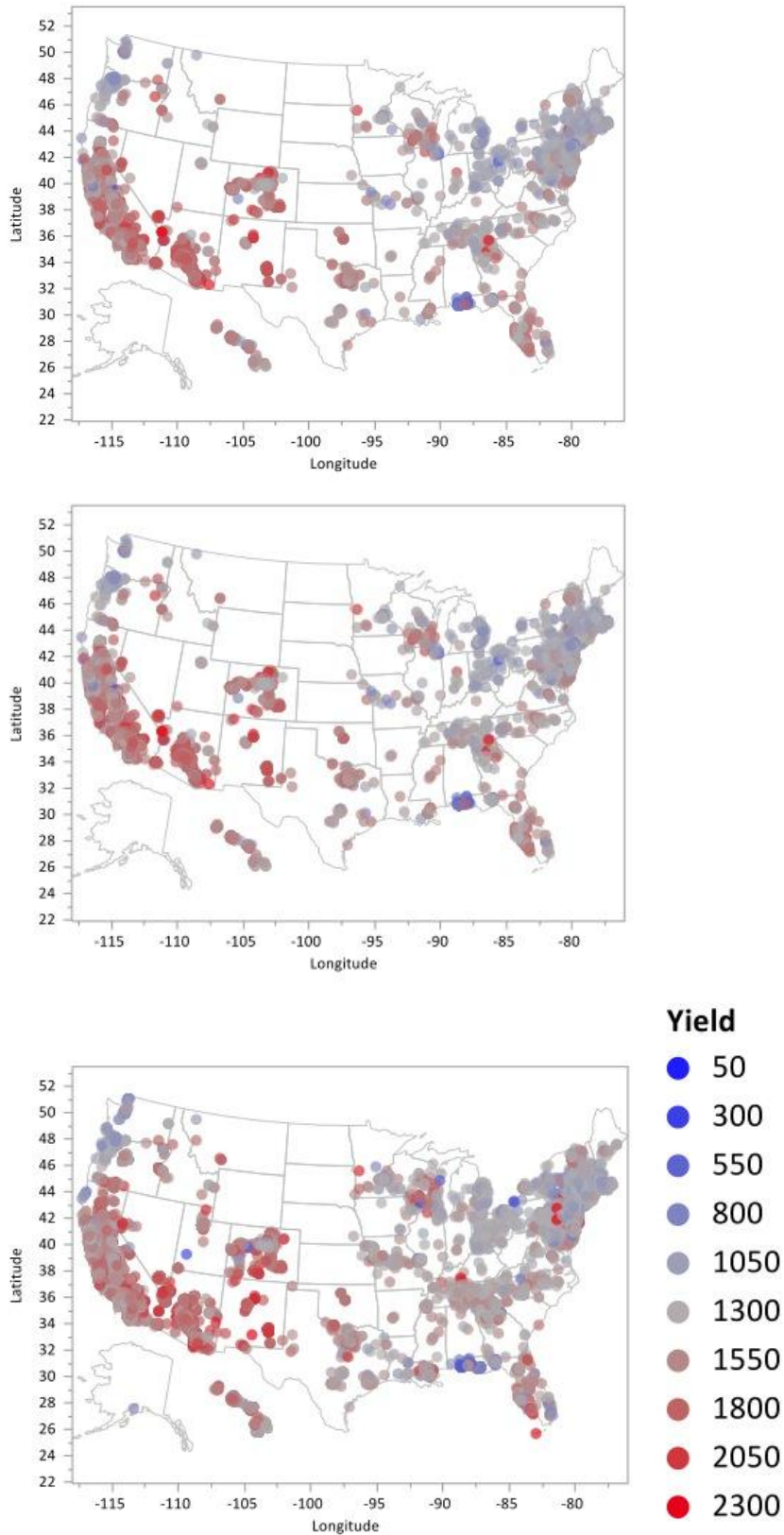

Figure 25: Annual yield for systems across the USA for 2010, 2011, and 2012, illustrating the relation of yield with climatic differences.

4.3.2 Data from the Internet

Using the web scraping techniques, performance data for 2914 systems in five European countries was collected. The distribution and average system size of the sample are shown in Table 1.

Table 1: Distribution and average system size for the Internet data.

Country	Number of Samples	Average System Size (kW _p)
Netherlands	728	11.08
Germany	764	15.60
Italy	532	13.10
France	325	15.09
Belgium	565	6.52

The majority of the installations are in the mid-range size category as 45% of the total installations is below 5 kW_p in size. The specific module technology present in the installation varies per country, with polycrystalline and monocrystalline silicon cells being the most popular, see Figure 26. Nevertheless, amorphous silicon type modules despite being the less favorable choice have a significant share among larger PV installations: the average size per PV system with this type of module is more than 20 kW_p in Germany and the Netherlands and approximately 15 kW_p in Italy and France. The monocrystalline and polycrystalline silicon based type of modules were used in smaller sized systems.

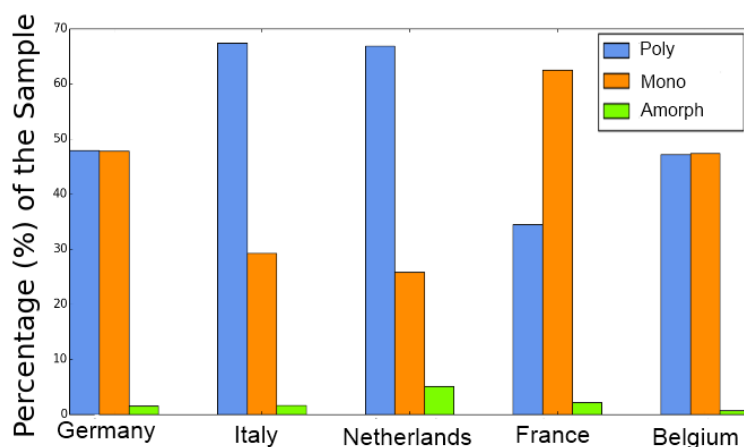

Figure 26: Market share of module technologies for each country.

The annual yield was calculated for the time period 2011-2013, see Figure 27. As is expected PV systems in Southern (European) countries have achieved higher yields than the Northern ones. There is an apparent decreasing tendency between the years 2011 and 2013 that ranges from 2% in the Dutch sample up to 11% to the German Sample, which may be related to annual country-dependent irradiation variations.

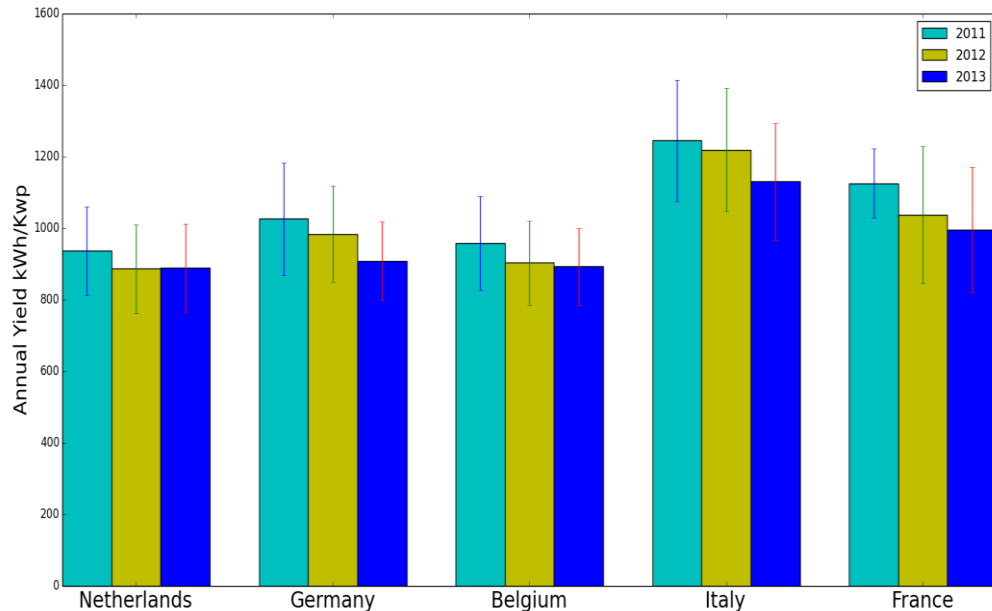
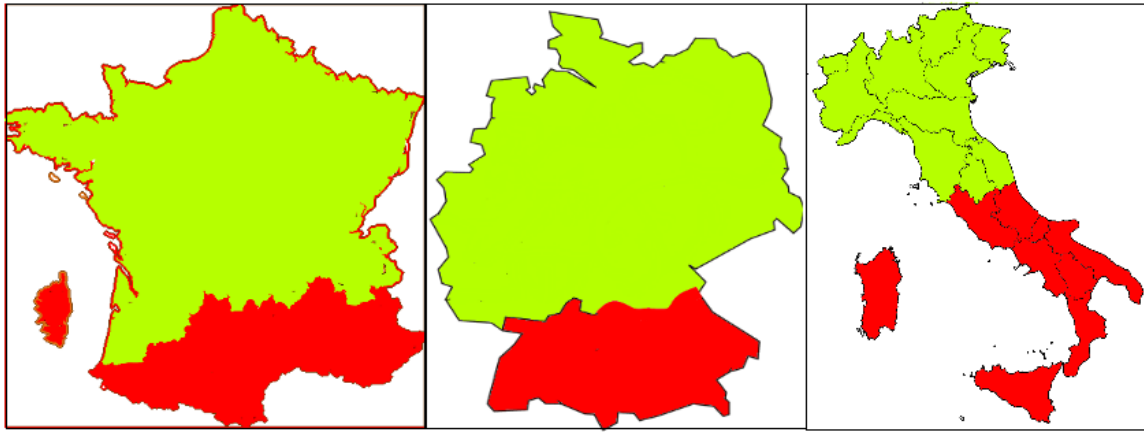

Figure 27: Annual yield for the time period 2011- 2013. Error bars indicate the standard deviation in the mean.

For a more comprehensive analysis samples from France, Germany and Italy have been separated in a Northern and Southern part according to the irradiation conditions of each area. As it is shown in Figure 28, Southern regions achieve 10-18% higher yields each year.



	Country	2011 kWh/kW_p	2012 kWh/kW_p	2013 kWh/kW_p
North	Germany	979 ± 153	937 ± 126	882 ± 109
South		1081 ± 154	1044 ± 121	922 ± 125
North	France	1030 ± 362	993 ± 201	959 ± 154
South		1099 ± 96	1092 ± 224	1103 ± 166
North	Italy	1219 ± 170	1177 ± 157	1094 ± 148
South		1352 ± 113	1337 ± 199	1288 ± 203

Figure 28: Annual System Yield per region (kWh/kW_p). Top: North/South division per country, France, Germany, Italy. Bottom: system yields.

Performance Analysis in the Netherlands

With the availability of irradiation data from meteorological stations, Performance Ratio analysis was possible for the Netherlands. The annual yield for 2012 and 2013 was 865 and 874 kWh/kW_p , respectively. Figure 29 shows the distribution of PR values for the year 2013. The average PR is $78 \pm 14\%$, which is also found for 2012 ($78 \pm 16\%$). The relatively low standard deviation reveals uniformity and a high concentration of all values around the mean of the distribution. However, in the 2012 PR distribution some 11% of the sample has PR values lower than 55% and 15.6% has PR values between 55 and 70%. This reveals weak points in the installation and operation of the aforementioned systems. On the other hand 47% of the systems have PR values in the range of 80%-95%. The results show that despite the technological advances and the monitoring program, still a considerable amount of PV systems were operating below the average regular standards. For 2013, the sample doubled in size as the result of the rapidly developing monitoring market in the Netherlands. The average annual yield is slightly larger, reaching 876 kWh/kW_p and only 3.2% appears to have serious malfunctions causing low yield with less than 600 kWh/kW_p . In comparison with 2012 results, 7 out of 10 installations that were in this category have significantly improved their performance in 2013, a sign that monitoring helps to detect a problem.

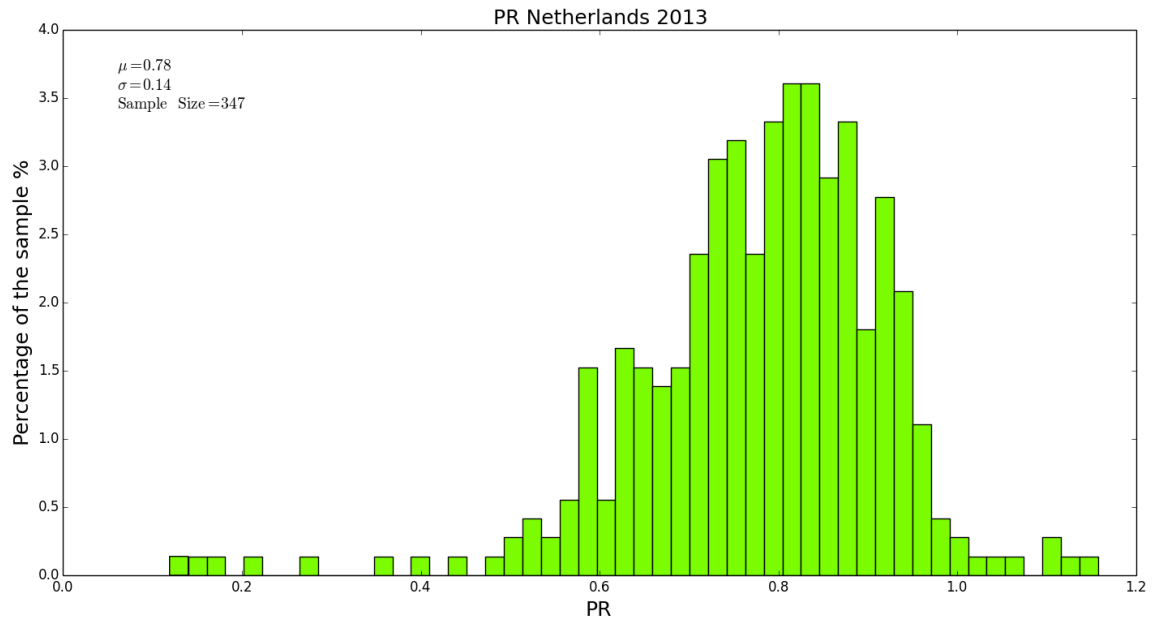

Figure 29: Distribution of PR values for 347 PV systems in the Netherlands in 2013.

The performance of this data sample was also analyzed according to the type of the module that is used in every system. As is illustrated in Table 2 system performance depends on the used technology: systems using polycrystalline silicon technology have higher PR than monocrystalline silicon technology in this sample comparison. Amorphous silicon modules perform worst in this sample comparison.

Table 2: Average PR per module technology

Module Technology	Percentage of systems	PR	Error
Polycrystalline	69.2%	80.0%	+/- 0.1%
Monocrystalline	22.0%	76.3%	+/- 1.0%
Amorphous	7.6%	64.5%	+/- 2.0%

Losses and Seasonal Variation

PV systems in practice are not able to reach 100% PR, as this value aggregates all the possible energy losses and it is influenced by a number of factors. The average losses that occur during the conversion from AC to DC current have been found to be 5.7% on average. However there are a number of systems that sustain losses from 10% up to 67% and that could be explained by wire losses, inverter malfunction, or shading. Studying the difference between AC and DC PR values could identify the type of system failure.

As PR is an indicator that is affected by temperature, there are also seasonal variations of the values. The sample from the Netherlands revealed that during the winter PR could reach 82.1% on average but in summer drops to 73.2%. Figure 30 depicts the dependence of the performance over ambient temperature. According to the scatter plot the system could reach optimum performance when the ambient temperature is below $-5\text{ }^{\circ}\text{C}$ and it gradually drops to 65% when the temperature exceeds $+25\text{ }^{\circ}\text{C}$.

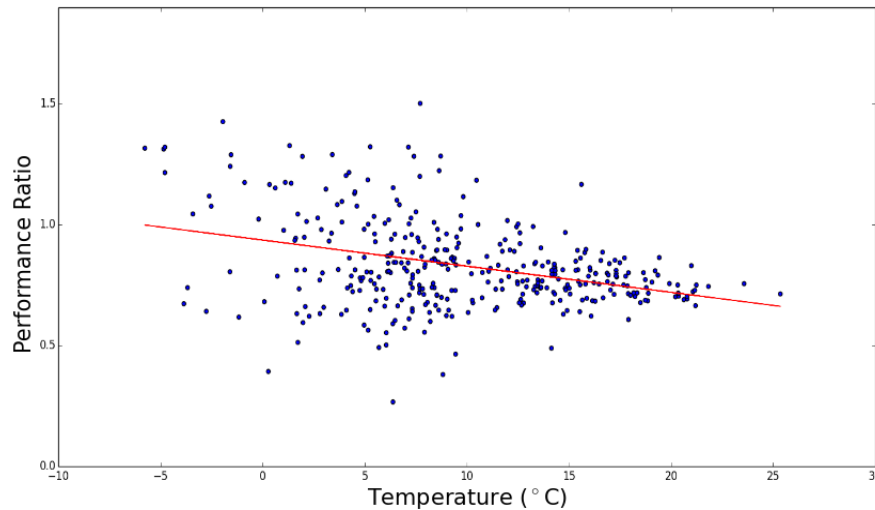

Figure 30: Performance Ratio as a function of ambient temperature.

4.4 Conclusion

This section has described the actual performance of PV systems for a number of countries. It shows that in general PV systems are “delivering what the salesman says”, albeit that not all systems in all countries are optimally performing. This can be caused by less optimal installations (orientation, tilt), as well as by malfunctions. Monitoring is the only means to discover those malfunctions.

A connection has been made between PV system performance and climatic conditions. It has been shown that the higher the irradiance, the higher the annual yield. The effect of ambient temperature affects performance: the higher the ambient temperature, the lower the performance.

The amount of data presently does not allow for a determination of degradation rate.

In order to follow the constantly growing PV market and the decentralized energy production it is necessary to develop more sophisticated monitoring tools. The creation of large databases has the advantage of high-resolution information that could give a clear image of the overall performance and the weak points of each installation. Moreover, it is possible to further study the performance mechanisms and the dependence over various factors.

It was found that the average system in the Netherlands has PR of 78% but there is still room for improvement. This also holds for other countries. Different geographical regions within the same country could achieve up to 17% higher yields. Continuation of this research in the following years in combination with additional irradiation measurements and more countries will expand our knowledge of PV operation and performance and would allow to show that PV works all over the globe.

5. Failure analysis of PV systems

5.1 Introduction

Whereas the previous activities dealt with examining the efficiency of PV systems the world over, activity 1.3 attempts to analyze the reasons for low efficiency.

Photovoltaic power producing systems have become more common as government incentives succeed in bringing the cost of a PV project down towards grid parity. In some countries grid parity has led to net metering schemes whereby no financial incentive is offered for energy producing, rather the income is accumulated by lowering the amount of electrical energy drawn from the grid by the home owner.

The older systems, those enjoying feed-in-tariffs, are prone to malfunction due to age; while the new systems built to take advantage of the sun's energy to lower electrical grid consumption through net metering will typically have a smaller internal rate of return.

These market realities lead to the necessity for finding a fault or failure in the PV system as soon as possible, even when no reference cell exists for calculating PR.

Another market reality is that small residential systems comprise the lion's share of system numbers and even total installed power in some countries. For example in California and Arizona, the total installed power of systems smaller than 10 kWp is around 60% of the total installed power of systems under 250 kWp [16]. Even in Italy, 3 GW of installed power is under 20 kWp in size [17]. Since the growth of PV penetration into the electrical distribution grid system is dependent on the utility's ability to ensure grid stability, it will be necessary to predict next day production for residential areas. Next day PV production prediction software will be available in the foreseeable future, however, prediction software works on meteorological data and system parameters, it is not defined as predicting failure for the next day.

5.2 Background

A fault or failure in a PV system is defined for our purposes here to be an event or situation that causes a drop in yield relative to what the system could potentially produce had not the fault or failure occurred.

PV solar energy technology is usually static in nature. Aside from fans used to cool inverters, and when tracking systems are used, there are no moving parts, and these systems run cool and quiet in comparison to conventional energy producing systems. It is not surprising then, that these systems tend to suffer from a lack of monitoring, since, in principle, no danger is involved, no serious safety issues exist, and monitoring is easily overlooked.

Apart from a total failure on the part of the inverter or damage due to connection problems that can lead to partial or total failure, there is no way of knowing for sure that a given perceived system underperformance is not due to weather conditions unless an irradiation sensor is used to calculate the system efficiency or Performance Ratio (PR).

When monitoring is undertaken, it is usually only in commercial and always in utility grade systems; seldom in smaller residential systems, due to the apparent relative high cost for PR monitoring when compared to the price of the system.

The best method for monitoring the efficiency of a PV system is PR monitoring. This method requires installation of a quality irradiation sensor (which may be complemented by a back panel temperature sensor). These necessary elements are seldom installed in residential systems, and if they are, there exists a question of accuracy after some years into the 25 year life cycle.

In order to enable fault analysis at some level, monitoring system designers have incorporated a methodology that compares one inverter output to that of the other. This works for systems with more than one inverter. However, the small residential system is often comprised of only one inverter and is therefore left with no methodology for monitoring fault or failure.

The purpose of the study is to enable a small system owner to understand when the system is undergoing or about to undergo a fault that will cause a reduction in yield.

5.3 Methodology

Groups of grid connected PV systems will be catalogued and monitored for temperature corrected PR, denoted as PR* in this document. The term "system" refers to an inverter and the panels attached to it. The term "group" refers to systems feeding into the same point of the distribution grid. Up to 10 Groups are located in a "Site" of geographical and meteorological distinction.

The monitoring system will alert as to a drop in efficiency and/or equipment failure. When a failure is encountered, the system parameters for the previous weeks will be examined in correlation to the month proceeding, for a total of two months. The data will be analyzed to find changes in patterns that cannot be attributed to the weather conditions, and that differ from neighboring systems. When a correlation is found, it will be catalogued.

The cataloguing will be used to calibrate machine learning algorithms being developed for this purpose.

All systems considered in this study are equipped with SMA inverters, due to the ability to input an additional URL address to the proprietary data logger, allowing for sending data in parallel to the Sunny Portal and to our database.

The typical Group size is 50 kWp, comprised of different combinations of inverter (system) sizes. Most systems are comprised of 3 tri-phase Tripower inverters; however a great many Groups are comprised of 6 to 12 single phase SMC and SB Inverters.

The data resolution is between 5 and 15 minutes, depending on the existing rate of DB writing initially installed and the ability to change the resolution vis-à-vis the system owner permissions. The resolution chosen as optimal for this purpose is 10 minutes. The 10 minute optimization was chosen based on the short winter days when as little as 6 hours comprise a production day. 15 minute resolution results in only 24 readings a day, while the 5 minute resolution packs the database in the summer with as many as 120 readings a day.

All values are based on averaging of at least 1 minute values. Meteorological values used for PR monitoring are 10 minutes averages of 15 second readings. The parameters monitored are solar irradiation using a silicon crystalline reference cell installed at 24° and sighted due south at azimuth 180°, ambient temperature and back panel temperature using a Pt100 sensor.

The meteorological station measures the back panel of one module of one system of one group system in a site. There are 20 sites, each in a different geographical or meteorological area.

5.3.1 Temperature corrected Performance Ratio

Temperature corrected PR calculations are performed using the site irradiation sensor and calculating back panel temperature based on ambient temperature, NOCT of the panel and irradiation readings.

The calculated back panel temperature is stored as a parameter as is the physical pack panel temperature, allowing for comparison between these values and their effect on PR.

A Site or Area of up to 10 Groups shares a meteorological data logger producing 10 minutes values of ambient temperature and solar irradiation. In some areas a pyranometer, particularly where thin film panels are included in the area, is also installed. Back panel temperature is recorded for one panel in one system of a single group in an area or site.

The following calculations are used for analytical calculation of a temperature corrected Performance Ratio (PR*), which is an extension to the Performance Ratio (PR) as defined in IEC 61724.

$$T_{mc} = T_{am} + (\text{NOCT} - 20 \text{ }^\circ\text{C}) * (G_i / 800 \text{ W/m}^2)$$

where:

T_{mc} : the calculated back panel temperature

T_{am} : the ambient temperature of the area

NOCT: a characteristic value for the specific panels in this system

G_i : the irradiation reading in W/m^2

Temperature correction coefficient used to remove the effect of temperature from the calculated PR is calculated by:

$$T_{corr} = (T_{mc} - 25 \text{ }^\circ\text{C}) * \gamma$$

where:

T_{corr} : the temperature correction coefficient

T_{mc} : the calculated back panel temperature

γ : is the temperature coefficient of the solar panel used in the system

The numerical value of the PR (described theoretically in previous chapters), then temperature corrected to receive PR*, is calculated here using specific parameters collected by using the following formula:

$$PR = E_{AC} / E_{irr}$$

where:

E_{AC} : the normalized AC energy in kWh/kWp for the period, calculated by dividing the system output by total system power

E_{irr} : the irradiation calculated from the power readings of irradiation sensor G_j for the period in kWh and normalized to 1 m²

$$PR^* = PR / (1 - T_{corr})$$

where:

T_{corr} : the temperature correction coefficient (see above).

5.3.2 Cataloging

The following system specifications will be cataloged:

- Inverter manufacturer, model, size in kW ac output
- Panel manufacturer, rated STC power, NOCT, nominal and SC current, open and working voltages, temperature Power coefficient
- Panels/string
- Strings/MPPT
- Angle of inclination
- Azimuth
- Sun angle, defined as the angle created by a ray running from the top of the first row back to the bottom of the second row
- Number of systems in the Group to which this system belongs

5.3.3 The monitoring

The monitoring system chosen for the study was "SolAmitec". The choice was driven by the user interface that allows for viewing and downloading any or all parameters from any time frame in the same excel file, and the ability to define set point alarms based on the following concepts.

All alarms can be configured to be operative during specific time periods.
The following alarming capabilities exist in the current version (7.24) of SolAmitec:

- 1) Any parameter can be assigned an alarming value to which it is compared. The alarm is raised when a the value is above, below or equal after a defined waiting period
- 2) Any parameter can be normalized by system size in Wp, all similar parameters are read, the highest value is labelled 100% and the rest are compared to this value. A value for the deviation percentage from the highest value can be set as an alarm
- 3) Communication alarms when values are not received from an entity in the group

The following Alarms are pre-existing in the SolAmitec monitoring system:

- No Power: when a system (inverter) has reported 0 power for a configurable period of time
- Low Power: when a system has reported a power lower than the best normalized inverter power in the group
- Low PR: when the PR for the specified system is lower than the defined PR for that system

The following system parameters are monitored and stored in the database per system:

- DC current (per MPPT)
- DC voltage (per MPPT)
- DC Power
- System earth resistance
- Ground leakage current (some systems)
- Fan voltage (some systems)
- AC voltage
- AC current
- AC total power
- Power factor (some systems)
- Frequency

5.3.4 Protocol

When one of the systems encounters a failure, that is, when the yield drops below what is expected as defined by a low PR that can't be explained by external circumstances, the data from the past month is examined to find behavior changes in pattern preceding the failure detection.

The incident is then documented to include:

- 1) Description of the failure
- 2) How the failure was detected
- 3) The parameters that showed a relationship to the failure
- 4) What was done to fix the failure

Statistical algorithms will be designed to correlate the failure to effected parameters such that this failure can be detected even when no PR* can be calculated, as is the case in almost all residential systems.

5.4 Results

At time of writing, the work on this study is still in progress. We report on 140 Groups comprising 560 systems, with the intent of reaching 200 Groups. The first installations have been monitored for 9 months, and we have found that there are "behavioral changes" in parameters before a failure is detected. As more systems are added and more time accrues, we hope to find consistent changes before specific failure types are detected. Cataloguing such changes will allow for small system owners to find and fix faults without the aid of PR monitoring. The following examples demonstrate the concept.

Example 1

Figure 32 portrays the DC voltage and current and the AC voltage of Inverter 209 two weeks before a fault in the inverter caused the inverter to cease production, as can be seen by the sudden drop of AC voltage and DC current, accompanied by a rise in DC voltage on the 14th of April.

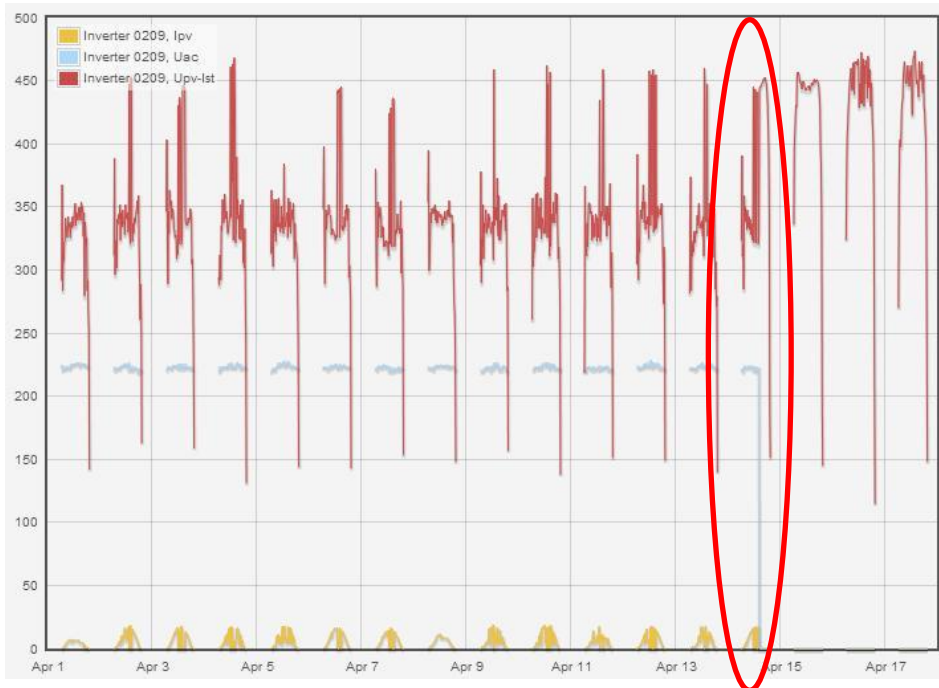

Figure 32: DC voltage (red), DC current (yellow) and AC voltage (blue).

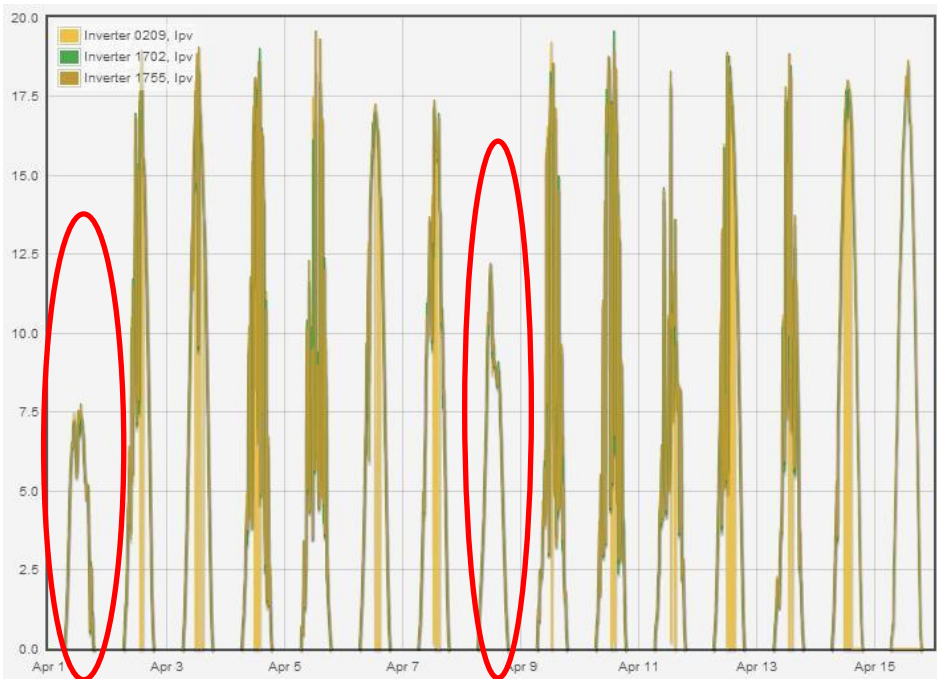

Figure 33: DC current of inverters 209, 1702 and 1755.

Before the failure on 14 April, no loss of yield was detected by the monitoring system when compared to the other inverters in the Group, nor was there a noticeable loss in the overall PR of the Group.

Figure 33 portrays the DC current of inverter 209 overlapped with that of two other inverters from the same Group. The two red circles mark days in which all three inverters were reading the same input current. The other days show that inverter 209, in yellow, was dropping out compared to the other inverters. These drop outs are for short periods of a few minutes during the day.

When the data from the previous month was examined, it was clear that the frequency of the current dropouts was on the increase, the first such drop out occurring some weeks previous, with increasing frequency until total failure on the 14th of the month.

Due to the short time span of each drop, and the fact that there were 12 other inverters, the loss of yield was too subtle to notice comparing yield between inverters of the Group and when calculating PR for the Group, as opposed to for each inverter (system).

So we have a transient phenomenon that was a precursor to this failure.

Example 2

Figure 34 portrays a failure caused by a faulty junction box connection on the back of the panel identified by the white arrow.



Figure 34: Fire due to junction box connection problems.

Examination of all parameters of the system prior to the event showed no parameter that behaved in an untoward manner, except for the system vs. ground isolation resistance.

Figure 35 shows the value of ground isolation from the system from over two months previous up to the day of the failure. The typical value for ground isolation is around 3 MOhm. In our case, the system was running with a ground isolation of just under 1.6 MOhm, dropping slowly over the weeks before the failure.

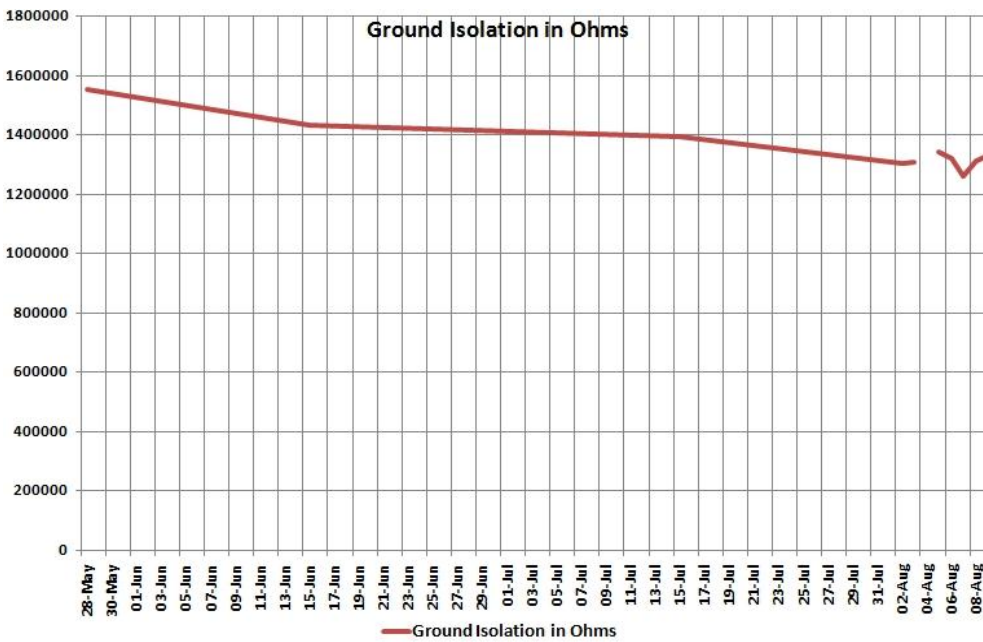

Figure 35: Ground isolation data from 2 months before the fault.

Example 3

Another example of the same parameter from a different system in a different group is found. In this case, there is a drop in yield that eventually caused the maintenance crew to search for the problem. When the problem was resolved, the data was examined and it was found that the isolation value for the inverter was dropping to below 0.8 MOhm some weeks before drops in power were recorded.

5.5 Discussion / analysis

Analysis of the use of specific parameters to point to upcoming failures requires many faults and failures to allow for statistical study. Unfortunately for this study, and fortunately for system owners, faults and failures are not every day occurrences.

As this study is running, machine learning algorithms are being designed to profile healthy system parameters and unhealthy system parameters. The analyzed data will be used to calibrate the machine learning software.

This study will have to run for some years to accrue the necessary data to accurately assume a potential failure based on the change in behavior of parameters and their interaction.

5.6 Conclusion / summary

The ability to predict failures by monitoring changes in system parameters offers the small system's owner the possibility to increase profitability by decreasing downtime without the necessity for purchasing and maintaining an accurate irradiance sensor and back panel sensor.

This is important to the grid operator as well, insofar as availability will be increased on the whole, making next day hourly predictions that much more accurate, leading to a more stable grid.

The methodology of this study is to analyze failures in systems to see what parameters changed before the failure was registered as a loss in energy production. Such changes in these parameters can then be assumed to be a harbinger of a drop in energy production.

The method used to find drops in energy production in our control groups is that of temperature corrected PR, requiring irradiance and ambient temperature monitoring coupled with algorithms that calculate when the efficiency is lower than it should be.

From these control groups, monitored by temperature corrected PR, we are developing algorithms that will predict future failures in systems with no need for meteorological monitoring by searching for these changes in parameter behavior in the monitored data. Since these changes in parameter behavior developed prior to the fault in our control groups, we assume that finding these behavior changes will alert to a similar failure in another system.

This study is slated to continue until the end of 2014. It is hoped that funding will be found to continue the study further, even expanding the number of groups.

References

- [1] N.H. Reich, B. Mueller, A. Armbruster, W.G.J.H.M. van Sark, K. Kiefer, Ch. Reise, *Performance Ratio revisited: Are PR > 90% realistic?*, Progress in Photovoltaics 20 (2012) 717-726
- [2] "IEC 61724 Std. Photovoltaic System Performance Monitoring-Guidelines for Measurement, Data Exchange and Analysis." IEC, 1998.
- [3] G. Blaesser and D. Munro, "Guidelines for the Assessment of Photovoltaic Plants Document A Photovoltaic System Monitoring," Commission of the European Communities, Joint Research Centre, Ispra, Italy, EUR 16338 EN, Issue 4.2 (June 1993), 1995.
- [4] European Commission "Global Europe EU performance in the global economy" 2006
- [5] IEA PVPS Task 2, "Country Reports on PV System Performance," International Energy Agency Photovoltaic Power Systems Programme, IEA-PVPS T2-05:2004, 2004.
- [6] IEA PVPS Task 2, "Cost and Performance Trends in Grid-Connected Photovoltaic Systems and Case Studies," International Energy Agency Photovoltaic Power Systems Programme, IEA-PVPS T2-06:2007, 2007.
- [7] F.J. Olmo, J. Vida, I. Foyo, Y. Castro-Diez, L. Alados-Arboledas, Prediction of global irradiance on inclined surfaces. Energy 24 (1999) 689-704.
- [8] M. Sengupta, P. Gotseff, and T. Stoffel, "Evaluation of Photodiode and Thermopile Pyranometers for Photovoltaic Applications," in 27th EUPVSEC, Frankfurt, Germany, 2012, pp. 3705–3708.
- [9] S. Mau and U. Jahn, "Performance analysis of grid-connected PV systems," in 21st EUPVSEC, Dresden, Germany, 2006, pp. 2676–2680.
- [10] U. Jahn and W. Nasse, "Operational performance of grid-connected PV systems on buildings in Germany," Prog. Photovoltaics Res. Appl., vol. 12, no. 6, pp. 441–448, 2004.
- [11] U. Jahn, W. Nasse, T. Nordmann, L. Clavadetscher, and D. Mayer, "Achievements of task 2 of IEA PV power systems programme: final results on PV system performance," in 19th EUPVSEC, Paris, France, 2004, pp. 2813–2816.
- [12] "IEC 60364-7-712 Std. Electrical installation of buildings - Part 7-712: Requirements for special installations or locations - Solar photovoltaics (PV) power supply systems," Int. Electro-Tech. Comm., IEC, 2002.

- [13] U. Jahn, D. Mayer, M. Heidenreich, R. Dahl, S. Castello, L. Clavadetscher, A. Frölich, B. Grimmig, W. Nasse, and K. Sakuta, "International Energy Agency PVPS Task 2: Analysis of the operational performance of the IEA Database PV systems," in 16th EUPVSEC, Glasgow, United Kingdom, 2000, pp. 2673–2677.
- [14] H. Haeberlin and C. Beutler, "Normalized Representation of Energy and Power for Analysis of Performance and on-line Error Detection in PV-Systems," in Proc. 13th EU PV Conf., Nice, 1995 pp. 934
- [15] Shelton Honda, Alex Lechner, Sharath Raju, Ivica Tolich, J.S. Mokri, Advisor, "Solar PV System Performance Assessment Guideline for Solartech" SJSU Solar Project-007, C, San Jose, California, January 2012 Rev
- [16] NREL website "The Open PV Project" <https://openpv.nrel.gov/>
- [17] Rapporto Statistico 2012 Solare Fotovoltaico, GSE, 2012, <http://www.gse.it/it/Statistiche/RapportiStatistici/Pagine/default.aspx> or <http://atlasole.gse.it/atlasole/>

Annex: Definitions

The following Table A1 presents an overview of the recorded and derived parameters for performance evaluation (adapted and extended from [2] and [5]).

Parameter	Symbol	Formula	Unit
Plant data			
Nominal power	P_0	at STC	kW
Array area	AA		m^2
Monthly operational data			
Year	$Year$		yyyy
Month	M		1 – 12
Modules cleaned	CM		0 – 1
Reference cleaned	CR		0 – 1
Time of monitoring activity	t_{MA}		h
Time not available to the system	t_{NAV}		h
Outage fraction	O	t_{NAV} / t	—
Ambient temperature	T_{am}		$^{\circ}C$
Module temperature	T_m		$^{\circ}C$
Irradiation horizontal	H		kWh / m^2
Irradiation in array plane	H_i		kWh / m^2
Energy from PV array	EA		kWh
Energy to inverter	E_{II}		kWh
Energy from inverter	E_{IO}		kWh
Energy to utility grid	ETU		kWh
Energy from utility grid	EFU		kWh
Monthly results in tables and diagramms			
Month	$Month$		1 – 12
Monitoring fraction	M	t_{MA} / t	—
Outage fraction	O	t_{NAV} / t	—
Reference Yield	Y_r	$H_{i,d}$	kWh / kW daily mean
Array Yield	Y_a	EA_d / P_0	kWh / kW daily mean
Final Yield	Y_f	$E_{IO,d} / P_0$	kWh / kW daily mean
Array capture losses	L_c	$Y_r - Y_a$	kWh / kW
System losses	L_s	$Y_a - Y_r$	kWh / kW
Performance ratio	PR	Y_f / Y_r	—
Mean array efficiency	η_{aA}	$EA / (H_i * AA)$	—
Efficiency of the inverter	η_{aInv}	E_{IO} / E_{II}	—
Overall PV plant efficiency	η_{aTot}	$E_{IO} / (H_i * AA)$	—
Summary report, diagramms			
Performance ratio	PR	annual values per plant and year	
Final Yield	$Y_{f,a}$	annual values per plant and year	
Mean array efficiency	η_{aA}	to the nominal efficiency, monthly values	
Irradiation in array plane	$H_{i,a}$	to the latitude, annual values	
Final Yield vs. Reference Yield	Y_f / Y_r	annual values per plant and year	

Table A1: Parameter

For the classical yield and loss quantities we use small letters when referring to instantaneous values or averages over a short recording period.

The *instantaneous* values as presented in Table A1 are calculated by normalizing the corresponding energy values (yields and losses) to the recording period over which the recorded samples have been averaged. Physically, they are averages over the recording period, which approximate the instantaneous values. The shorter the recording period, the better is the approximation. The period should be no longer than one hour. In practice, these data are usually treated as instantaneous values and they reflect irradiance and power rather than irradiation or energy. As stated in [14], these quantities allow a much more detailed analysis of system performance and are very useful for on-line error detection by using data collected with a high resolution, e.g. every second.

The derived parameters presented in Table A1 are briefly described below in line with [2], [10], [12].

Instantaneous reference yield (y_r)

$$y_r = \frac{G_I}{G_{STC}} \quad (1)$$

Array yield (Y_A)

$$Y_A = \frac{E_{DC}}{P_o} \quad (2)$$

Instantaneous array yield (y_A)

$$y_A = \frac{P_{DC}}{P_o} \quad (3)$$

P_{DC} is the is the measured DC power of the system [kW]

Capture losses (L_C)

$$L_C = Y_r - Y_A \quad (4)$$

Instantaneous array capture losses (l_C)

$$l_C = y_r - y_A \quad (5)$$

System yield (Y_f)

$$Y_f = \frac{E_{AC}}{P_o} \quad (6)$$

Instantaneous system yield (y_f)

$$y_f = \frac{P_{AC}}{P_o} \quad (7)$$

System losses (L_S)

$$L_S = Y_A - Y_f \quad (8)$$

Instantaneous system losses (l_s)

$$l_s = y_A - y_f \quad (9)$$

Performance Ratio (PR)

$$PR = \frac{Y_f}{Y_r} \quad (10)$$

Instantaneous performance ratio (pr)

$$pr = \frac{y_f}{y_r} \quad (11)$$

Array Performance Ratio (PR)

$$PR_A = \frac{Y_A}{Y_r} \quad (12)$$

Instantaneous array performance ratio (pr)

$$pr_A = \frac{y_A}{y_r} \quad (13)$$

Operational Data

Additional information on some parameters:

M - Monitoring fraction

The monitoring fraction (M) is calculated from the hours in the month (t) and the hours of monitoring activity (t_{MA}):

$$M = t_{MA} / t$$

The range is 0, for no monitoring to 1, for full monitoring.

O - outage fraction

The outage (O) refers to the down-time of the PV system and not to the monitoring and is calculated from the 'hours of PV production' (inverter on) and the sunshine hours.

The outage fraction is:

$O = t_{NAV} / t_{sun} = \text{Time not available to the system} / \text{total sunshine hours available for production.}$

or

$O = 1 - (\text{hours of PV production} / \text{total sunshine hours available for production})$.

or

$O = 1 - (t_{\text{prod}} / t_{\text{sun}})$.

The range is 0, for full PV production to 1, for no production.

T_{am} - ambient temperature

Per definition the average ambient temperature (T_{am}) is the mean value over a 24 hour period.

T_m module temperature

The mean module temperature is calculated as follows:

$$T_{m, \text{eff.}} = \sum (G_i * T_m) / \sum (G_i)$$

resulting in the effective module temperature during sunshine for a given time period.

This is because the mean module temperature is depended to the irradiation and only relevant during sunshine hours.

For further information about the IEA – Photovoltaic Power Systems Programme and Task 13 publications, please visit www.iea-pvps.org.



ISBN 978-3-906042-21-3



9 783906 042213 >